



The Vector CSM E-Mobility Measurement System

CSM Web Seminars



CSM **Xplained**
measurement technology

Innovative Measurement and Data Technology

Challenges for measurement technology

- ? ▶ Distributed measurement points
 - decentralized and modular measurement system
- ? ▶ Synchronous acquisition of physical measurement variables
 - Power measurement requires 100% synchronous sampling of current and voltage
- ? ▶ Synchronous acquisition of ECU data and bus data
- ? ▶ Autonomous acquisition, processing and storage of measurement data streams

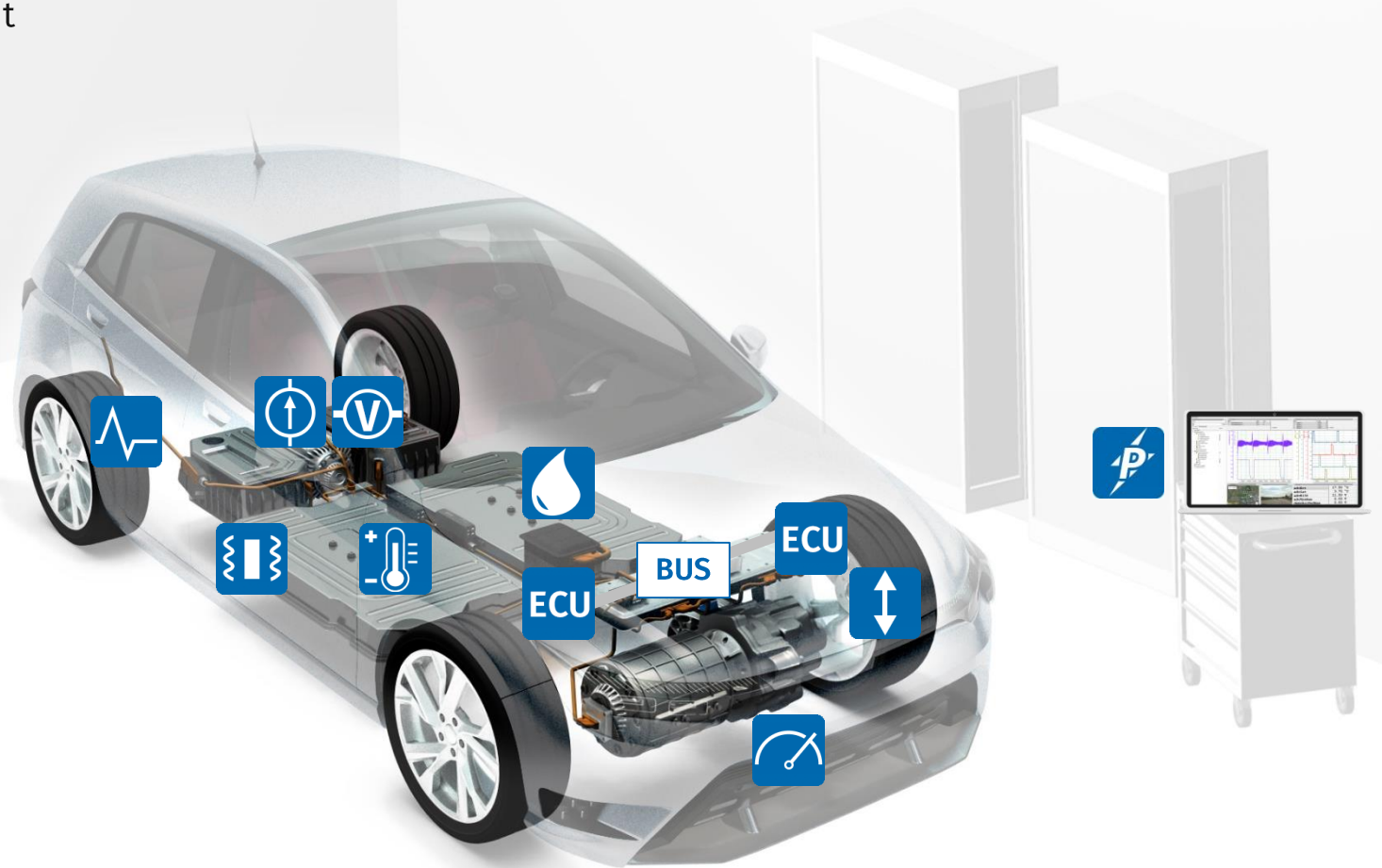

The Vector CSM E-Mobility Measurement System

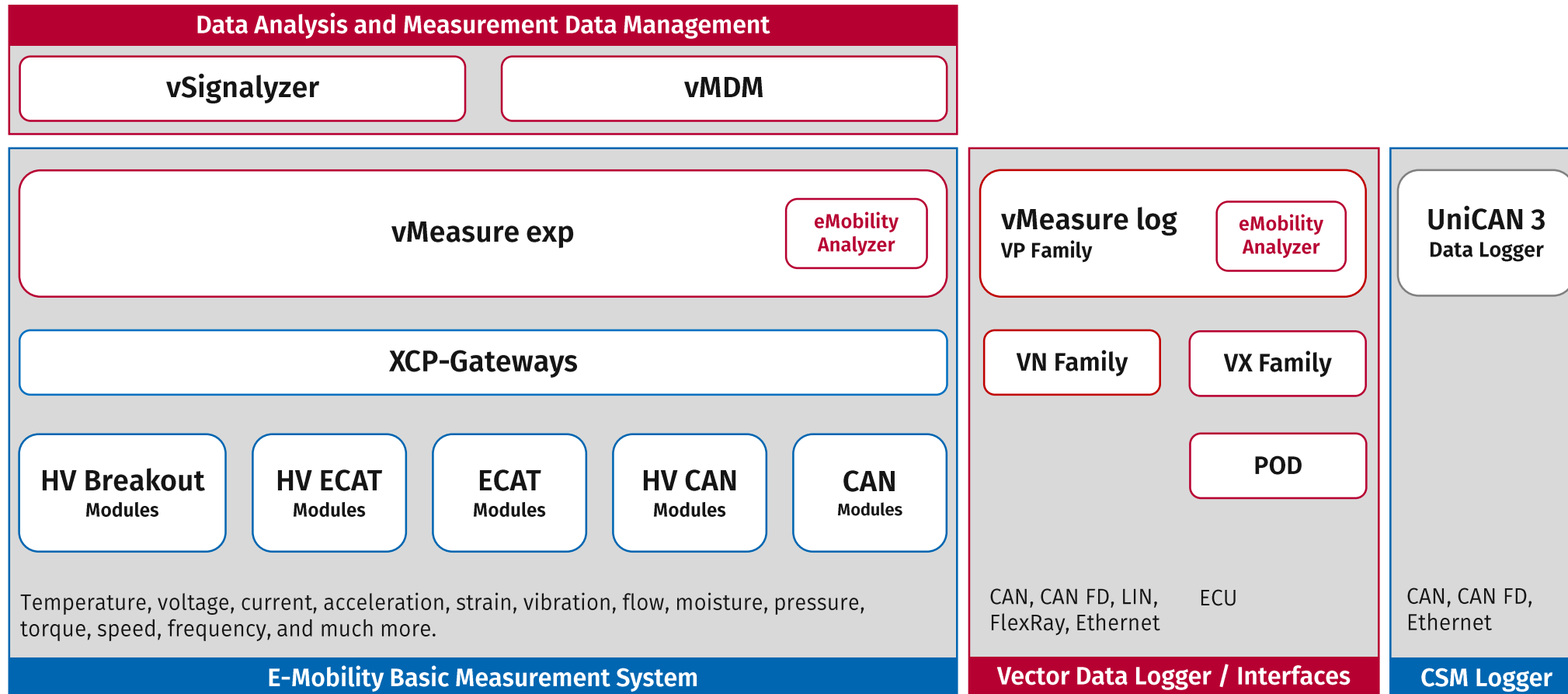

The Vector CSM E-Mobility Measurement System

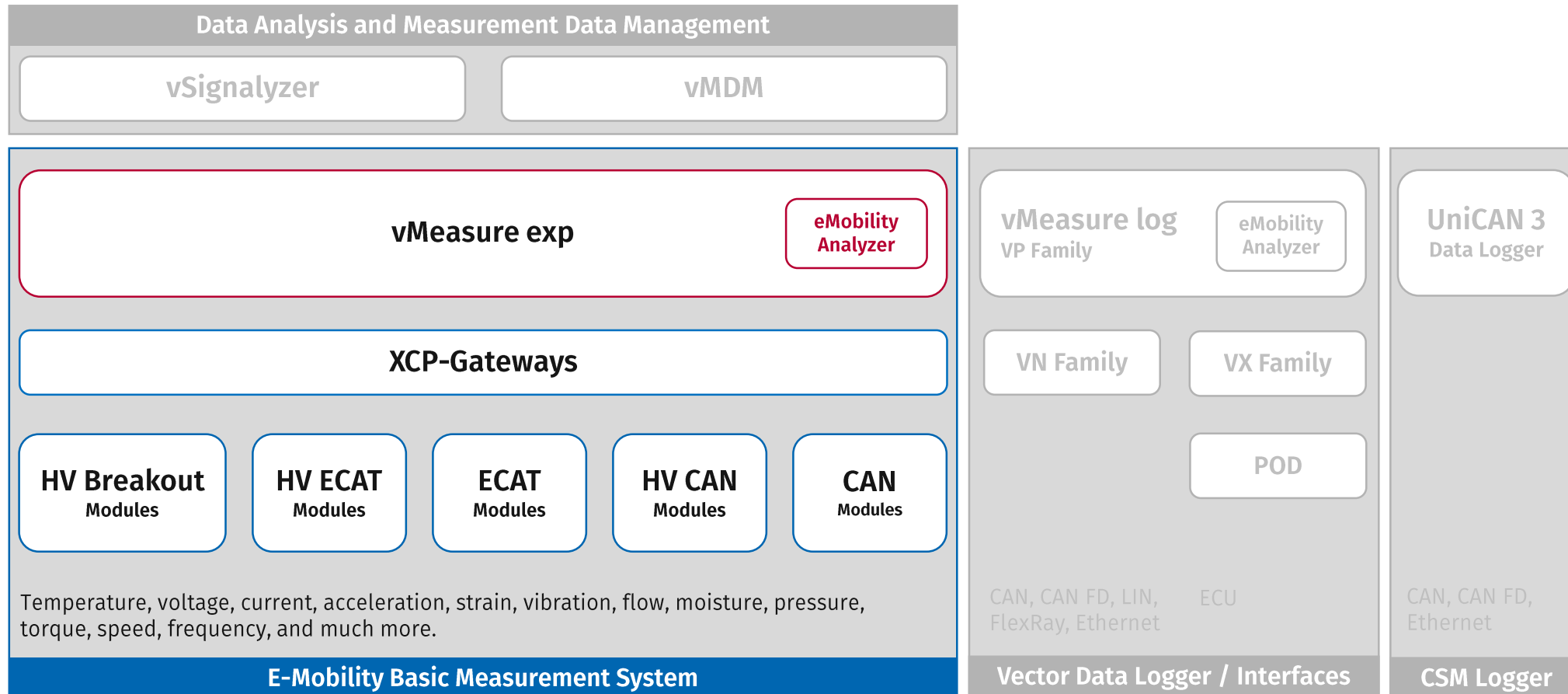

E-Mobility Basic Measurement System

Data acquisition, visualization, online data processing and synchronization



vMeasure exp

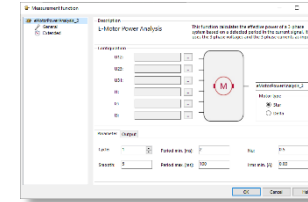

eMobility Analyzer





Temperature, voltage, current, acceleration, strain, vibration, flow, moisture, pressure, torque, speed, frequency, and much more.

E-Mobility Basic Measurement System

E-Mobility Basic Measurement System

Acquisition of physical measurement variables

Testing of an electric power train

  ► Synchronous measurement of current and voltage between HV battery and inverter

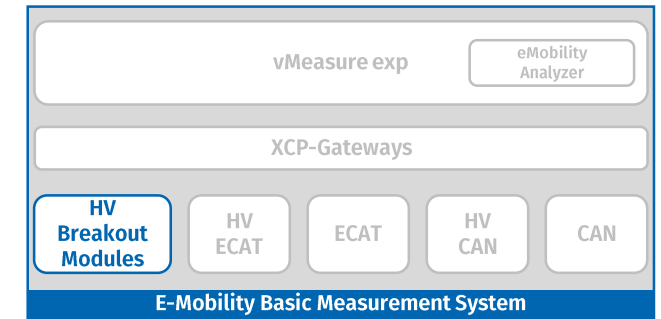
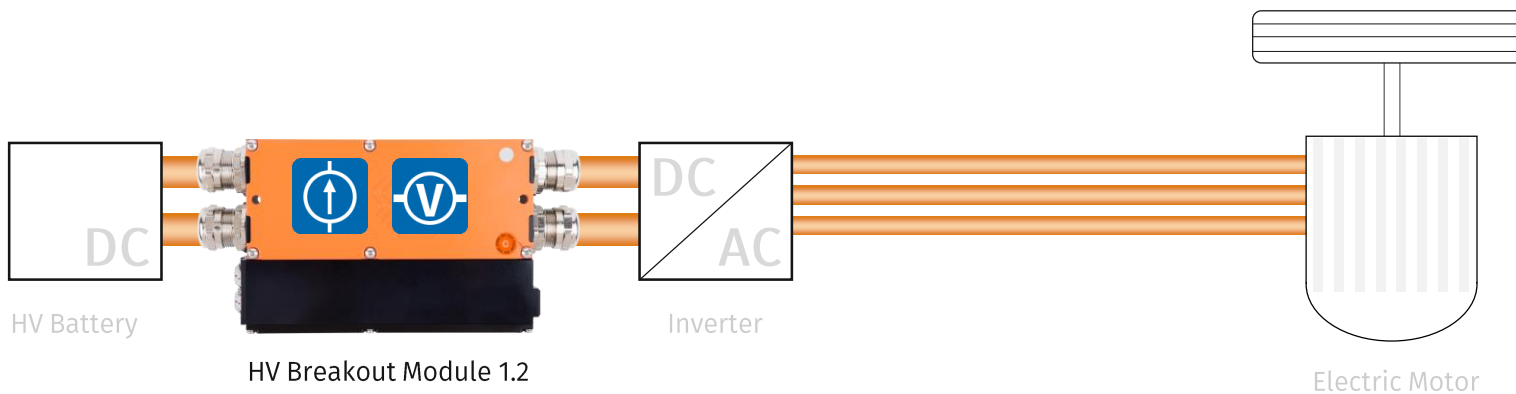



Find
HV Breakout Modules
on www.csm.de

E-Mobility Basic Measurement System

Acquisition of physical measurement variables

Testing of an electric power train

-  Synchronous measurement of current and voltage between HV battery and inverter
-  Acquisition of speed and torque

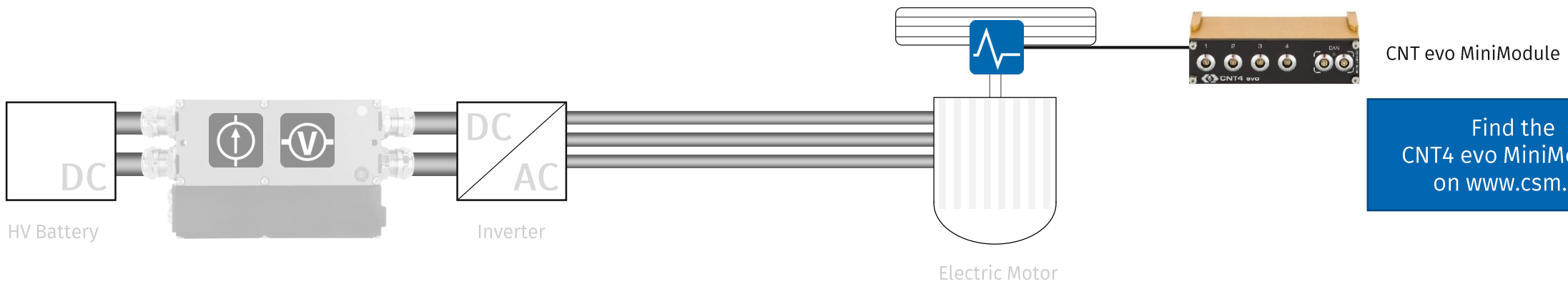
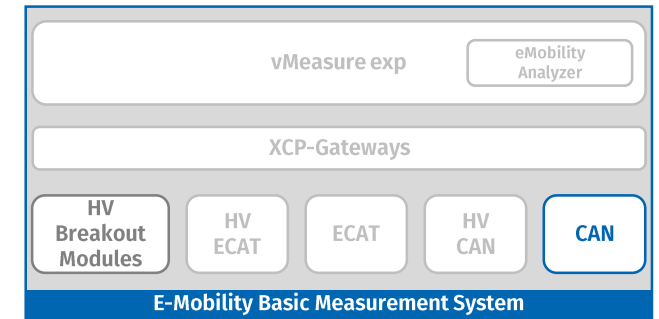

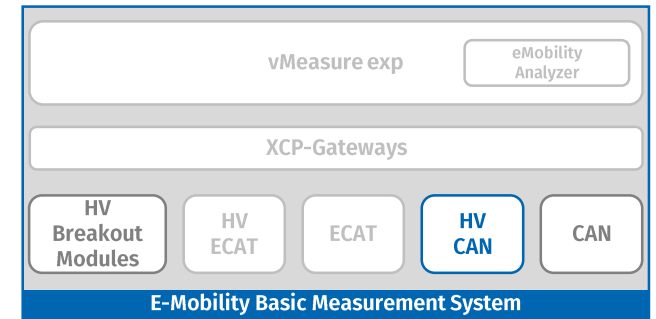

E-Mobility Basic Measurement System

Acquisition of physical measurement variables



Testing of an electric power train

-  ▶ Synchronous measurement of current and voltage between HV battery and inverter
-  ▶ Acquisition of speed and torque
-  ▶ Parallel temperature measurements in inverter and electric motor

Find HV-safe temperature measurement modules on www.csm.de

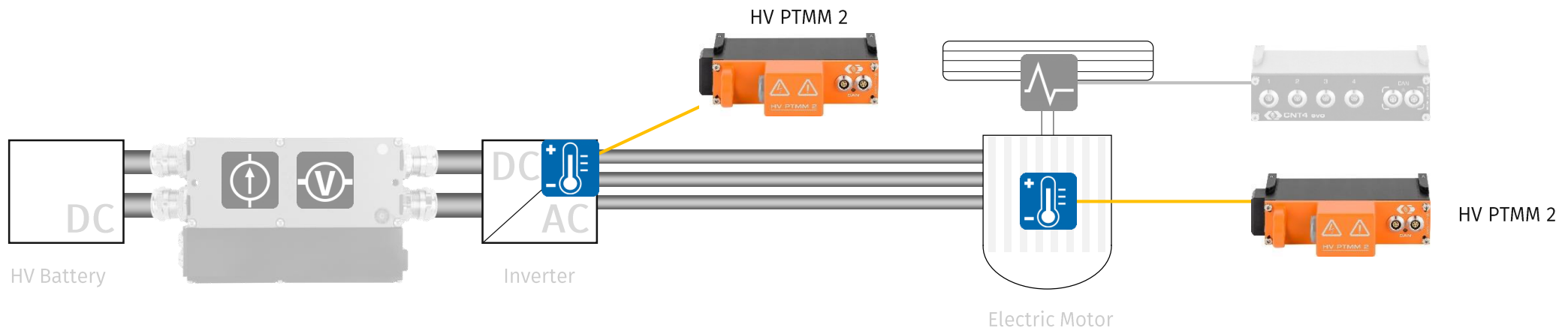



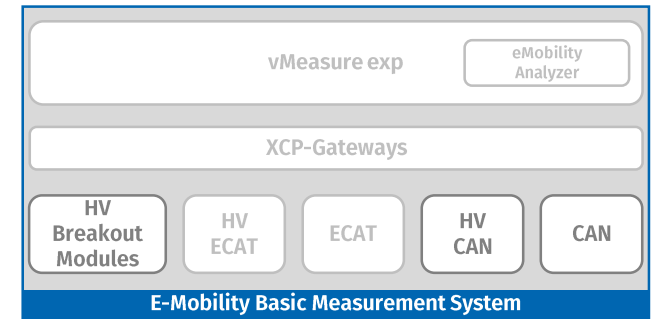

E-Mobility Basic Measurement System

Acquisition of physical measurement variables



Testing of an electric power train

-  Synchronous measurement of current and voltage between HV battery and inverter
-  Acquisition of speed and torque
-  Parallel temperature measurements in inverter and electric motor
-  Calculation of the efficiency of the powertrain in real time

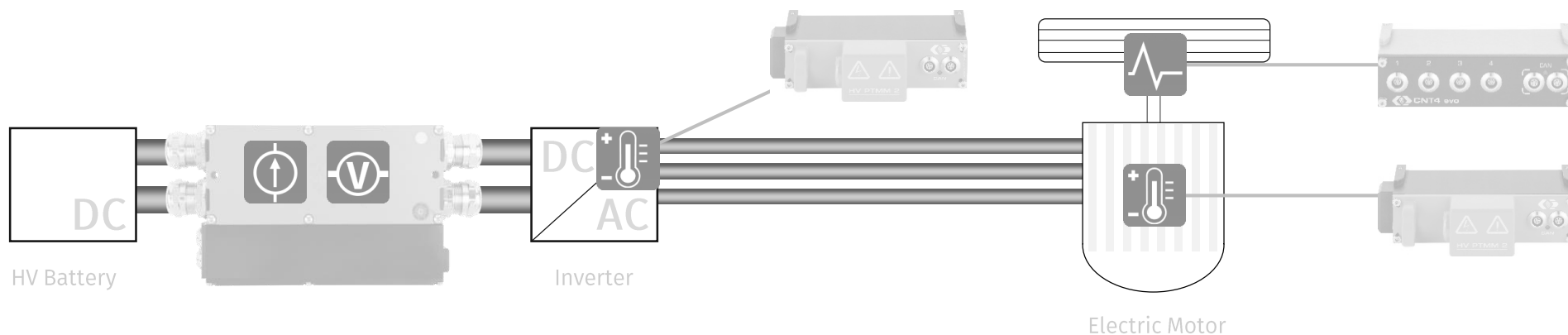

E-Mobility Basic Measurement System

Acquisition of physical measurement variables

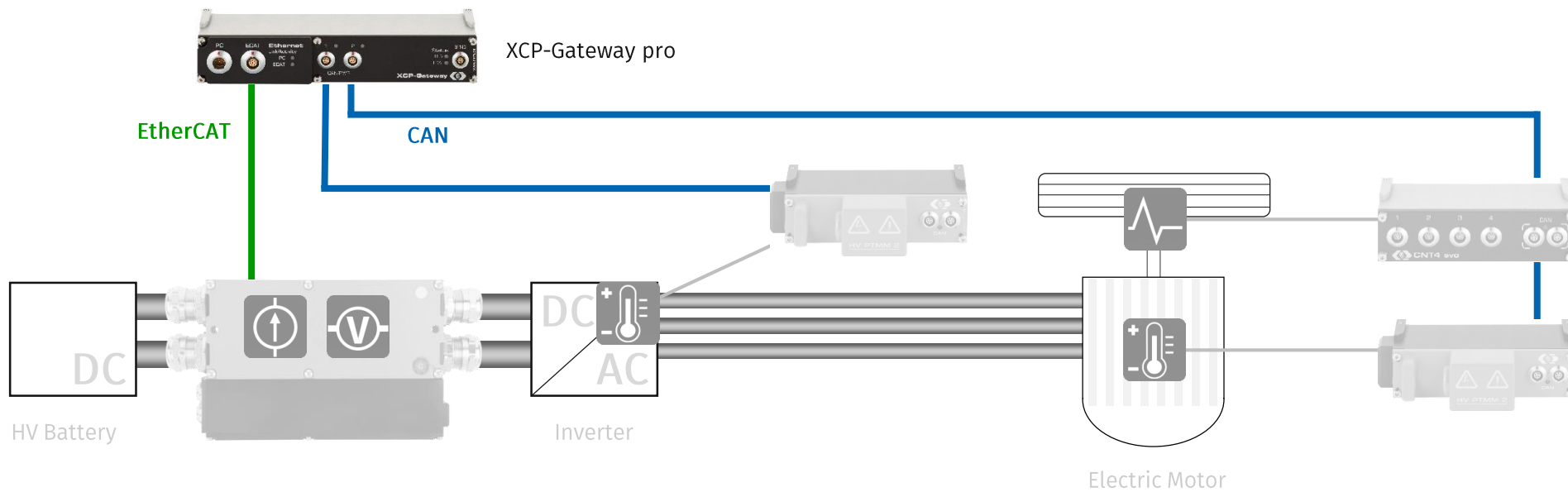
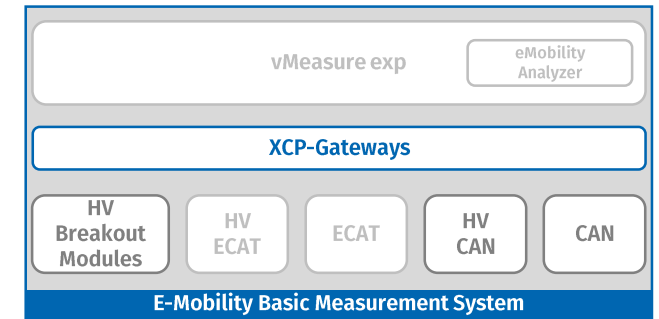

XCP-Gateway

Explore the XCP-Gateway
on www.csm.de



Synchronization and bundling

- ▶ EtherCAT® Master: Time synchronization for all EtherCAT modules (1 μ s)
- ▶ XCP-on-Ethernet slave with PTP (IEEE1588) time synchronization
- ▶ 1 or 4 EtherCAT ports
- ▶ 2 CAN ports
- ▶ 1 Ethernet port to PC

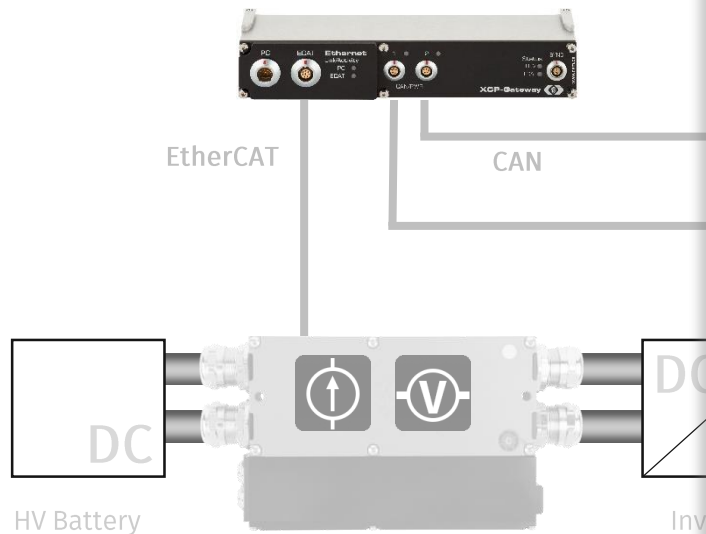

E-Mobility Basic Measurement System

Calculation of physical measurement values

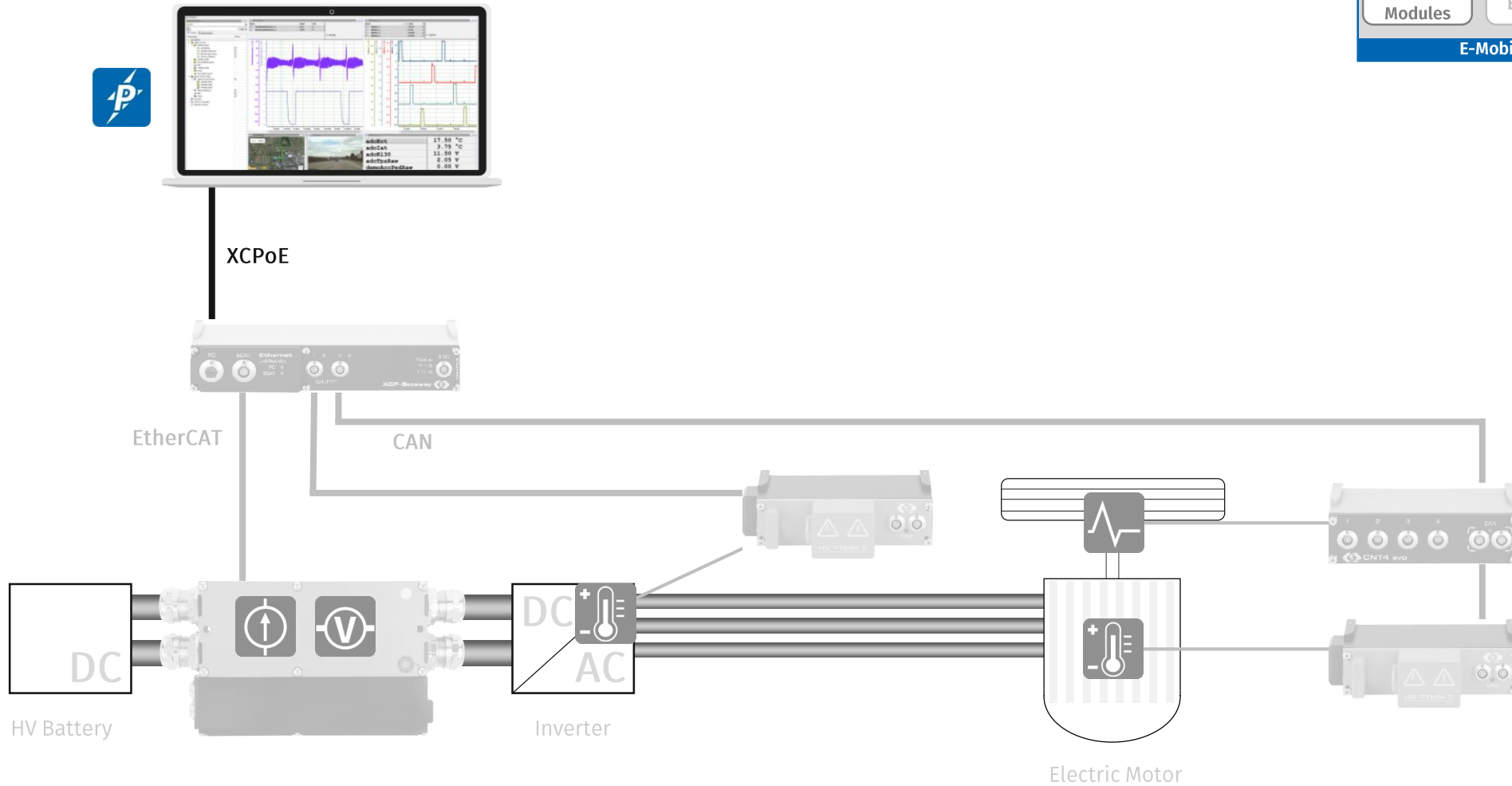

The screenshot shows the software interface for the E-Mobility Basic Measurement System. It features a red-bordered box at the top containing 'vMeasure exp' and 'eMobility Analyzer'. Below this is a white box labeled 'XCP-Gateways'. Underneath are five buttons: 'HV Breakout Modules', 'HV ECAT', 'ECAT', 'HV CAN', and 'CAN'. At the bottom is a blue bar with the text 'E-Mobility Basic Measurement System'.

E-Mobility Basic Measurement

Calculation of physical measurement

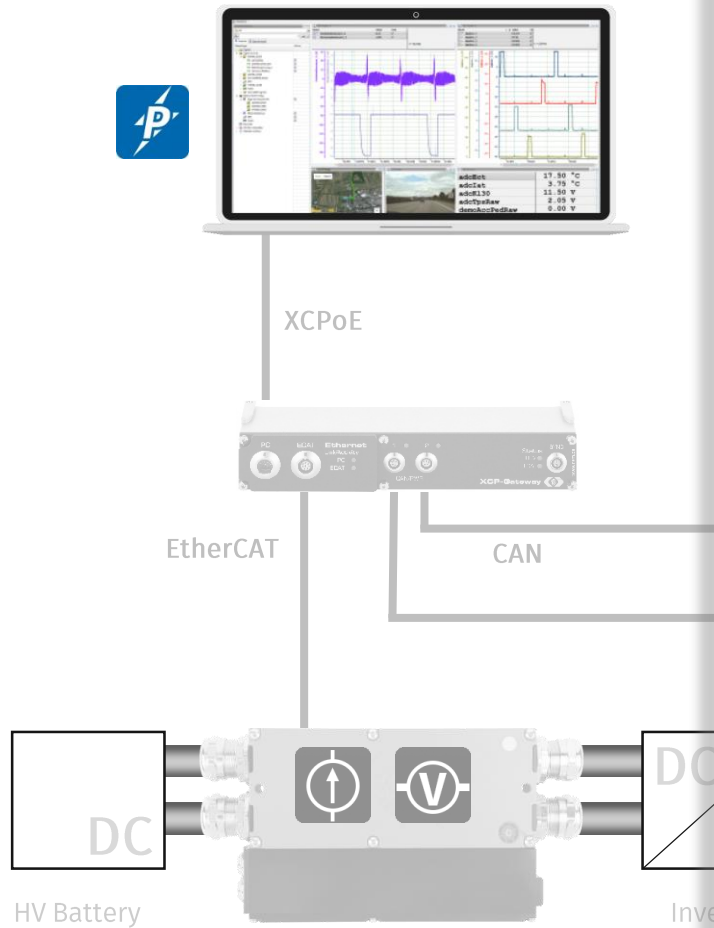

vMeasure exp – Data acquisition software

- ▶ Multithreading functionality
- ▶ Time synchronized data acquisition from
 - CSM measurement modules (HV BM, ECAT, CAN)
 - Vehicle buses (Ethernet, Flexray, CAN FD, ...)
 - ECUs
 - video, GPS
- ▶ Online calculations and scripting
- ▶ Multiple visualization



E-Mobility Basic Measurement

Calculation of physical measurement

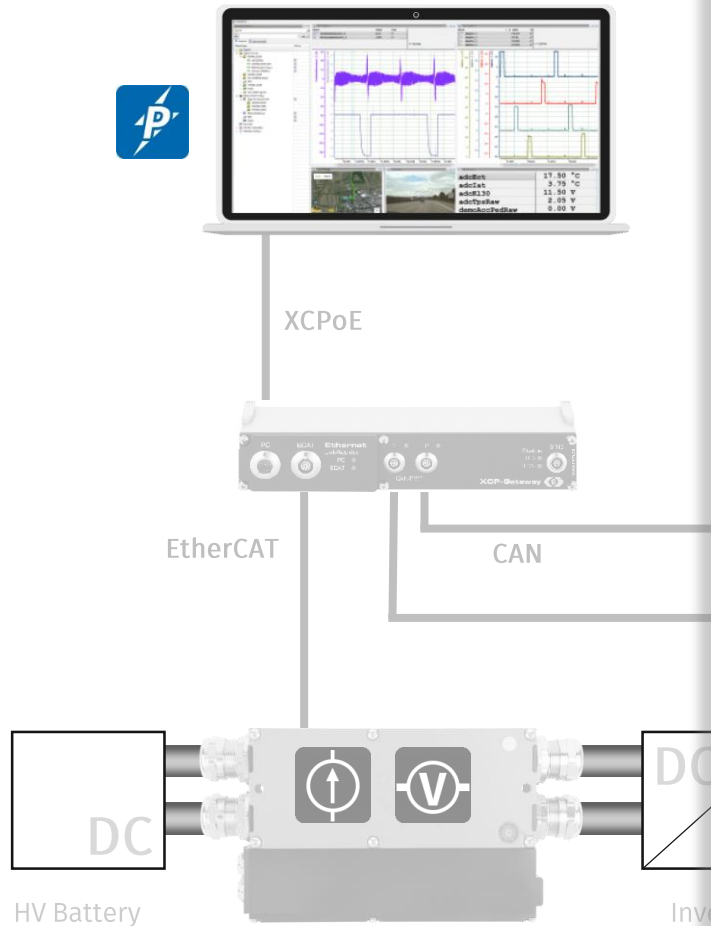

eMobilityAnalyzer - Function library

The eMobilityAnalyzer enables real-time analysis of

- ▶ DC/AC voltages and currents
 - Ripple, Slope, TrueRMS, ...
- ▶ Power analysis
 - Active power, apparent and reactive power, power factor
- ▶ Harmonic analysis
- ▶ PWM analysis
- ▶ Mechanical power and axis power
- ▶ Energy consumption
- ▶ Efficiency
- ▶ Inverter, charging system, e-motor

All measurement data are also **available for offline data processing.**

E-Mobility Basic Measurement

Calculation of physical measurement

eMobilityAnalyzer - Function library

The eMobilityAnalyzer is a function library that is optimally harmonized with the CSM measurement modules.

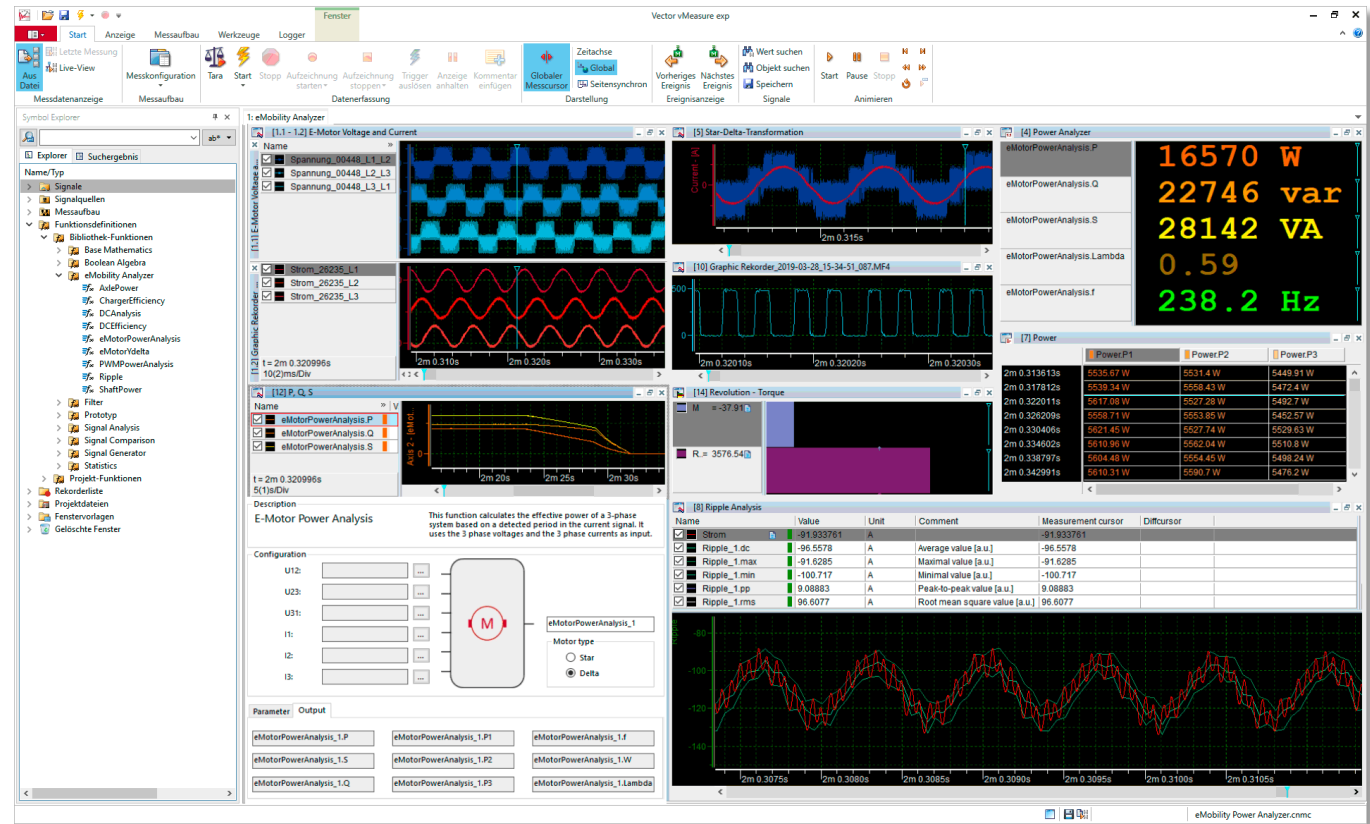
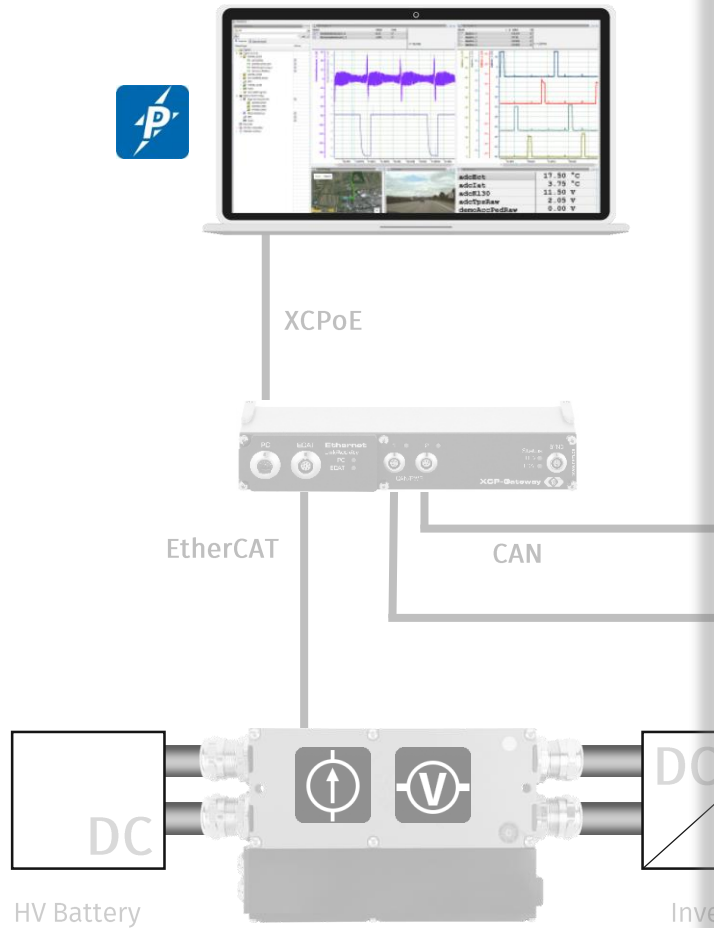

E-Mobility Basic Measurement

Calculation of physical measurement

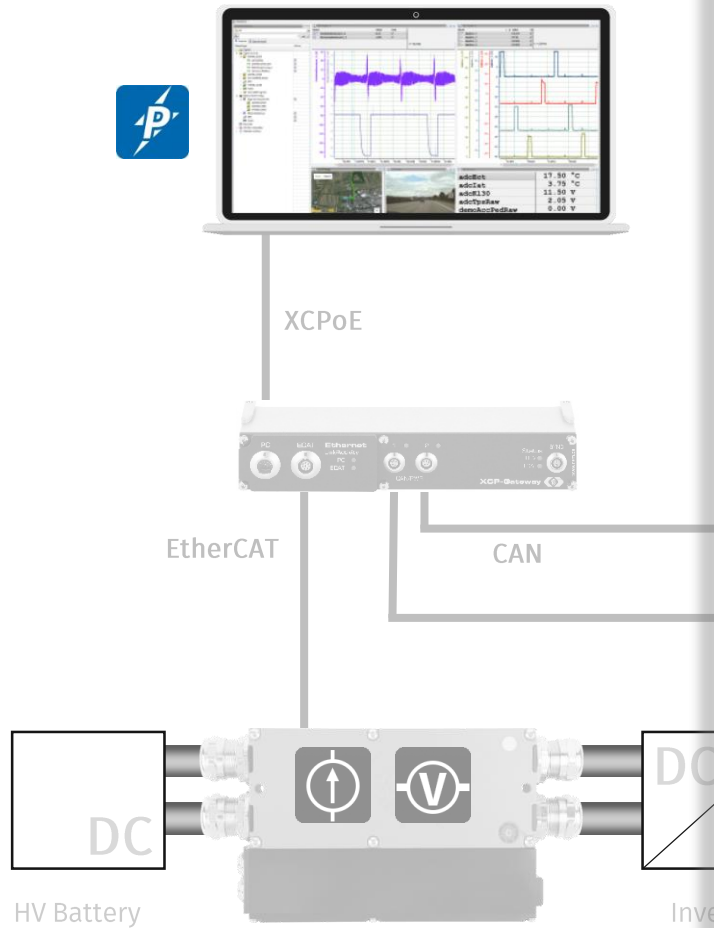

eMobilityAnalyer - Function library

Measurement function

eMotorPowerAnalysis_2

- General
- Extended

Description

E-Motor Power Analysis

This function calculates the effective power of a 3-phase system based on a detected period in the current signal. It uses the 3 phase voltages and the 3 phase currents as input.

Configuration

U12: [] ...

U23: [] ...

U31: [] ...

I1: [] ...

I2: [] ...

I3: [] ...

Motor type

Star

Delta

Parameter Output

Cycle:	1	Period min. [ms]:	2	Nu:	0.5
Smooth:	5	Period max. [ms]:	100	Irms min. [A]:	0.00

OK Cancel Help

The Vector CSM E-Mobility Measurement System with CANape

- ▶ All functions of the measurement system are also available in CANape
- ▶ Same user interface as vMeasure exp
- ▶ eMobility Analyzer is integrated in CANape
- ▶ Smart Logger with CANape log
- ▶ Additionally: ECU calibration / characteristic adjustment

Numerical and graphical adjustment window allows convenient adjustment of characteristic curves and fields

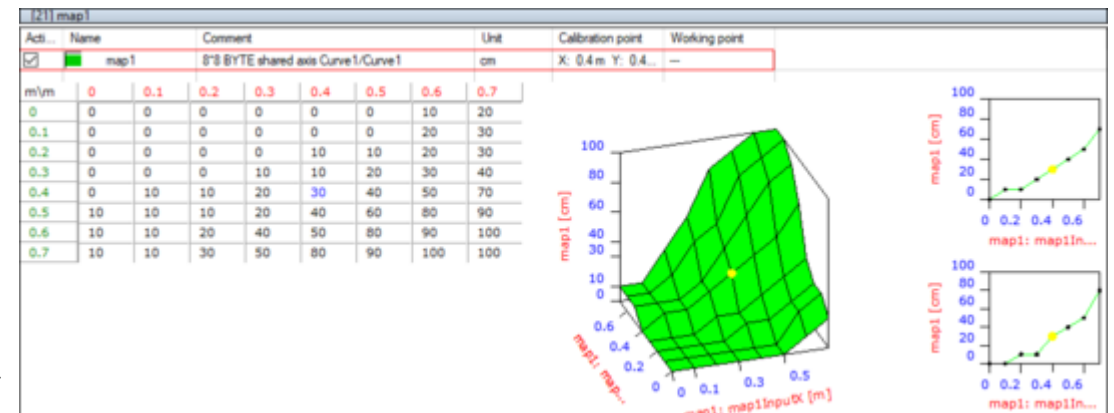

E-Mobility Basic Measurement System

Calculation of physical measurement values

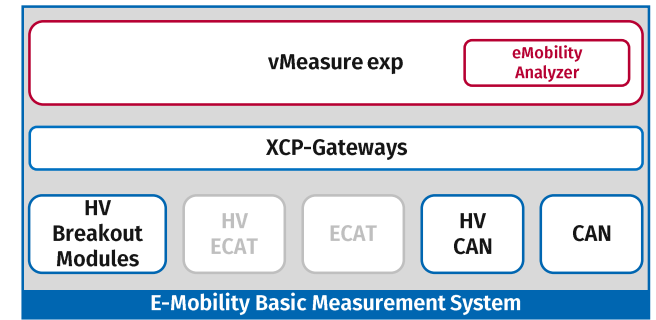
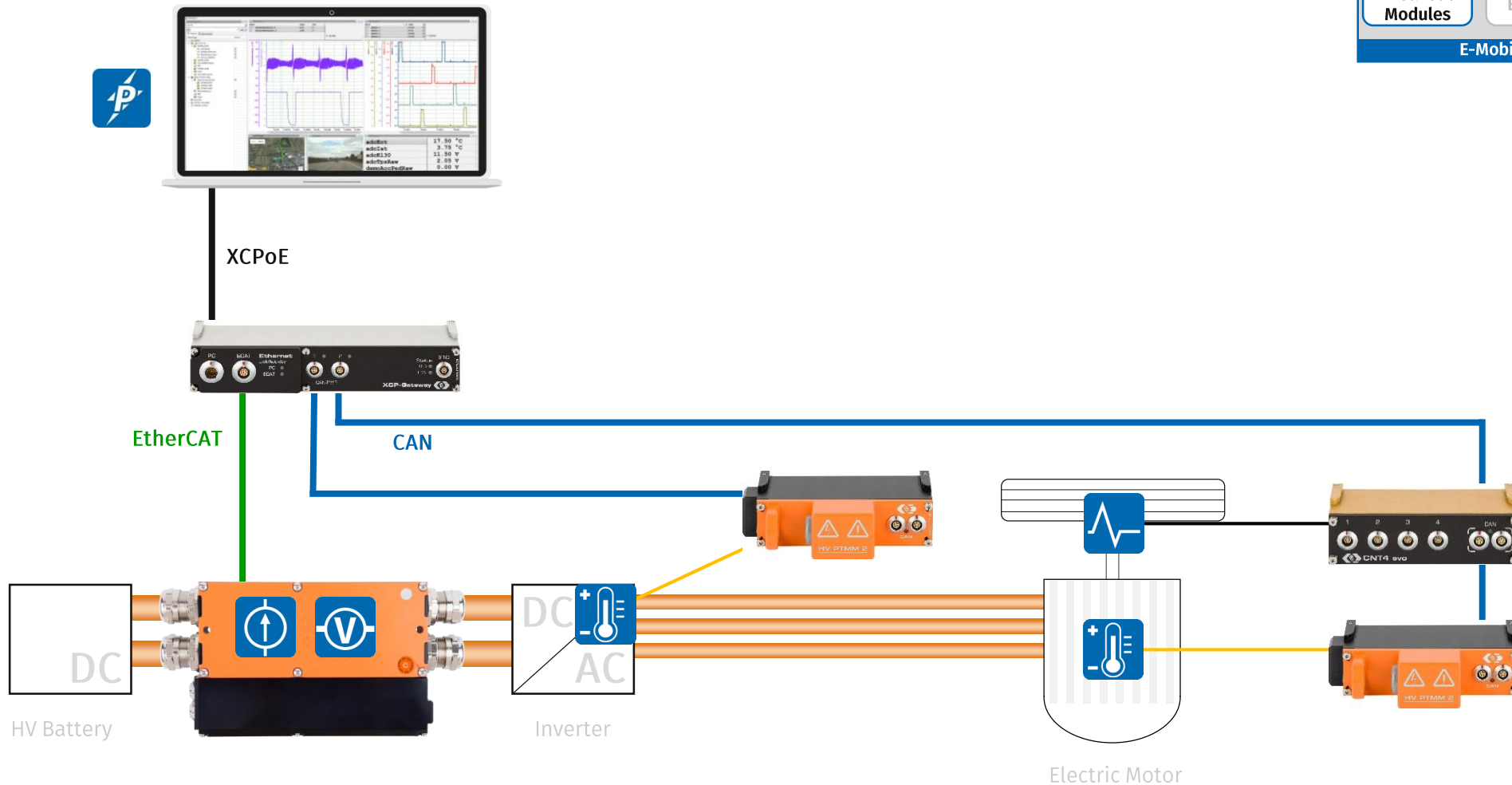

Read the application example on www.csm.de



Challenges for measurement technology

- ✓ ▶ Distributed measurement points
 - decentralized and modular measurement system
- ✓ ▶ Synchronous acquisition of physical measurement variables
 - Power measurement requires 100% synchronous sampling of current and voltage
- ? ▶ **Synchronous acquisition of ECU data and bus data**
- ? ▶ Autonomous acquisition, processing and storage of measurement data streams

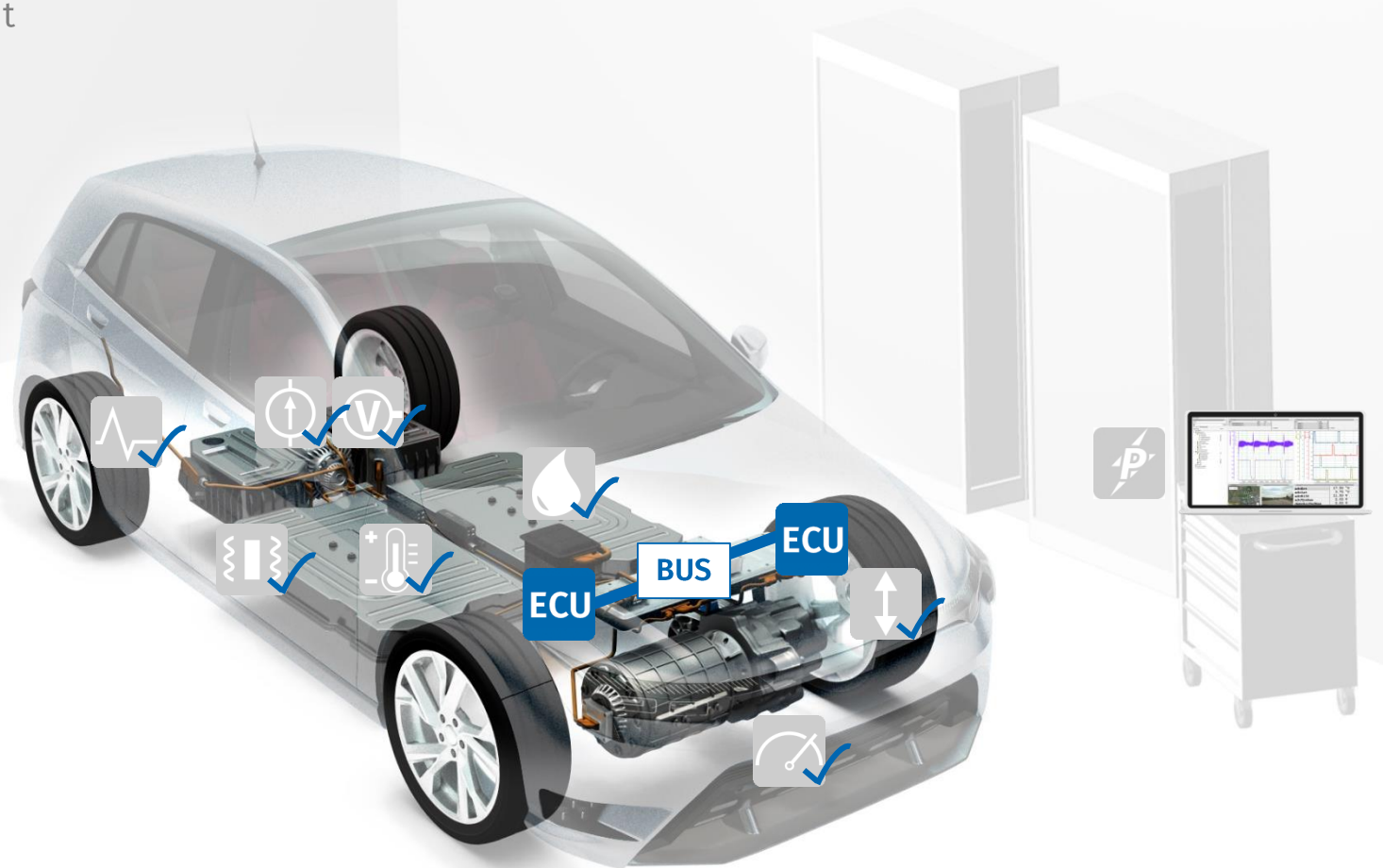

The Vector CSM E-Mobility Measurement System

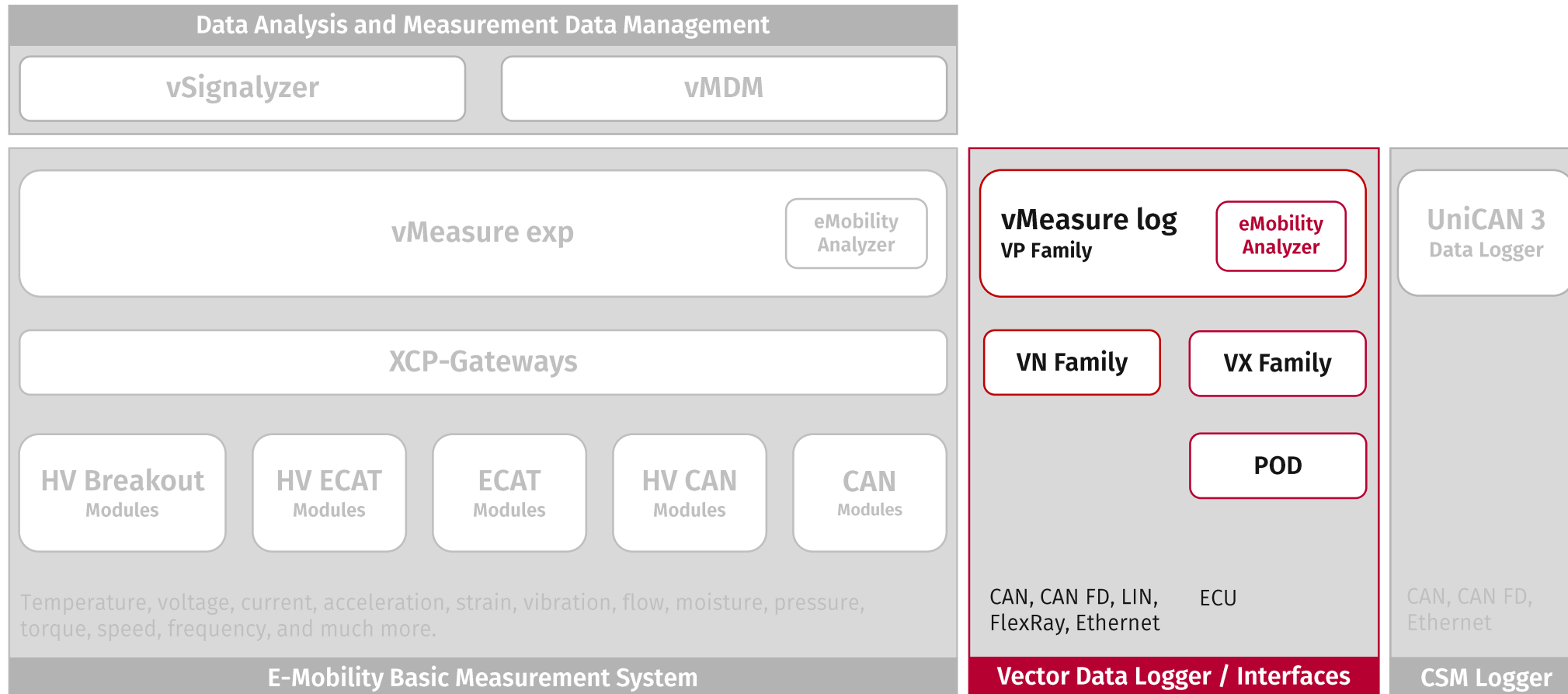

Basic measurement system + ECU data

Additional acquisition of data from control units

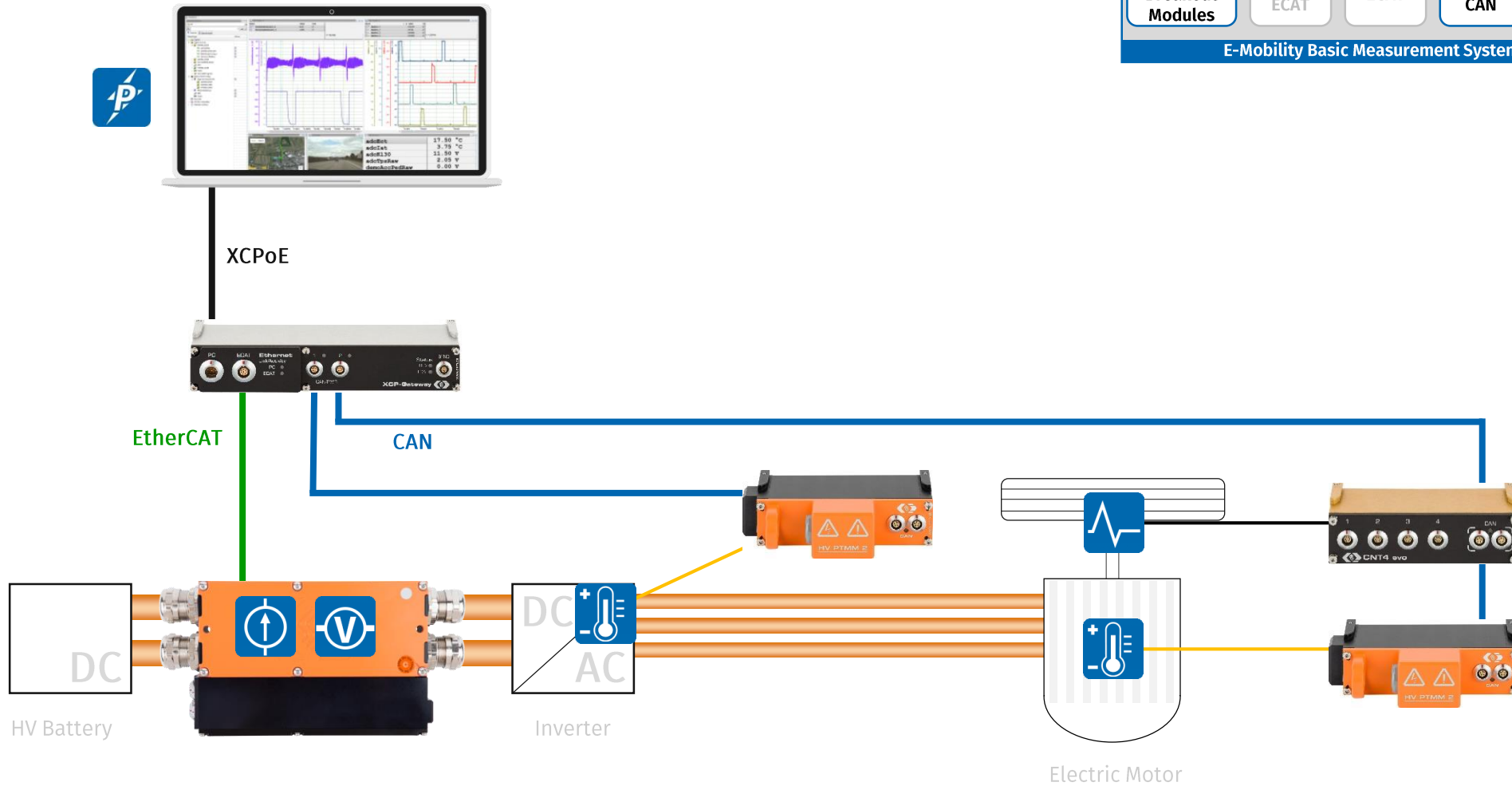

The software interface consists of several components:

- vMeasure exp** and **eMobility Analyzer** (top right)
- XCP-Gateways** (middle)
- HV Breakout Modules**, **HV ECAT**, **ECAT**, **HV CAN**, and **CAN** (bottom left)
- vMeasure log VP Family** and **eMobility Analyzer** (top right, greyed out)
- VN Family** and **VX Family** (middle, greyed out)
- POD** (bottom right, greyed out)
- Vector Data Logger / Interfaces** (bottom, greyed out)

E-Mobility Basic Measurement System

Basic measurement system + ECU data

Additional acquisition of data from control units

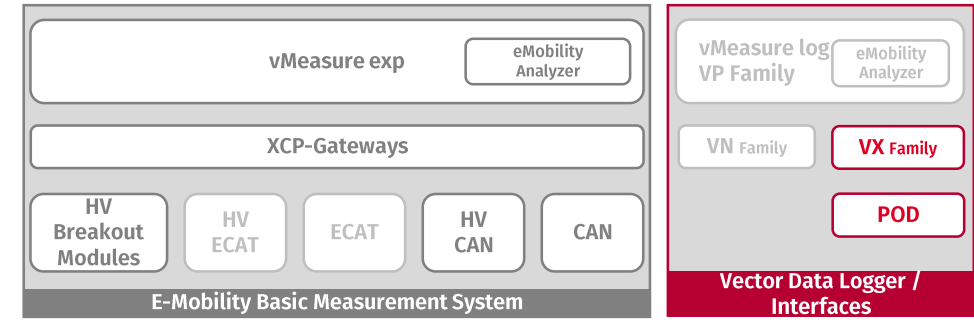
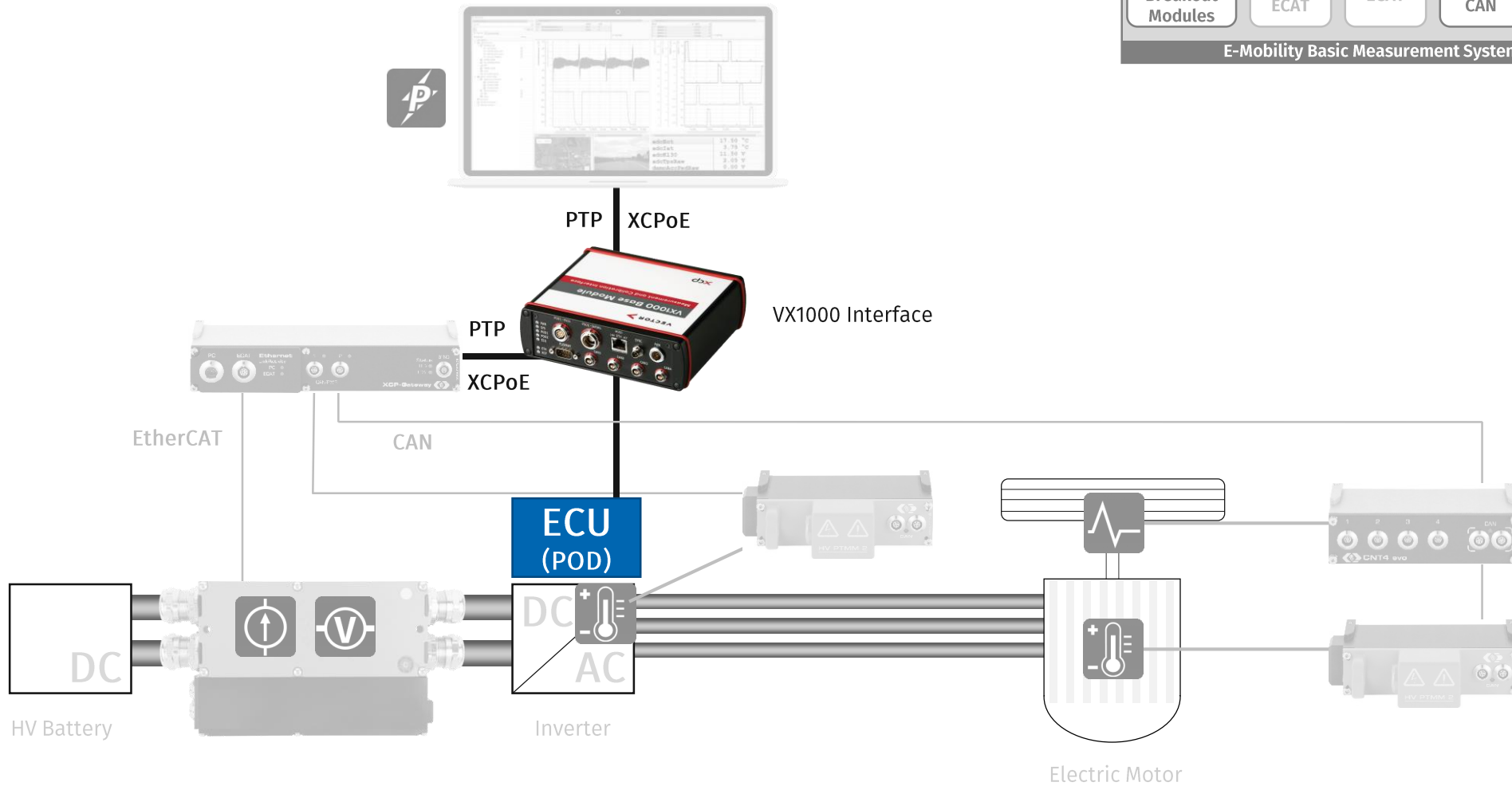

Basic measurement system + ECU data

Additional acquisition of data from control units

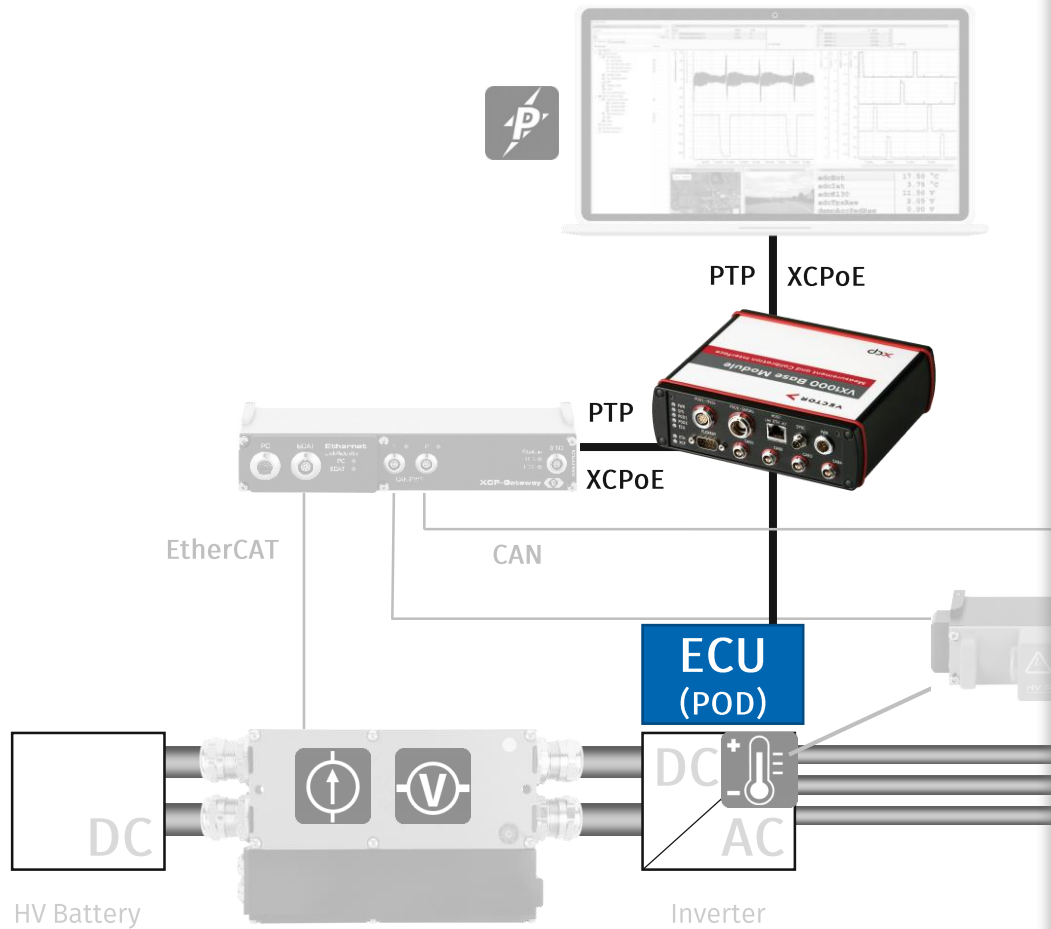

VX Family

- ▶ ECU measurement and calibration
- ▶ Interfaces between ECUs and vMeasure exp
- ▶ Can measure multiple ECUs simultaneously
- ▶ POD (Plug on Device) interfaces are available for numerous microcontroller debug ports
- ▶ Measurement data, bus data and ECU data can be measured simultaneously and synchronously
- ▶ PTP Slave



Basic measurement system + ECU data + bus data

Additional acquisition of measurement data from vehicle buses

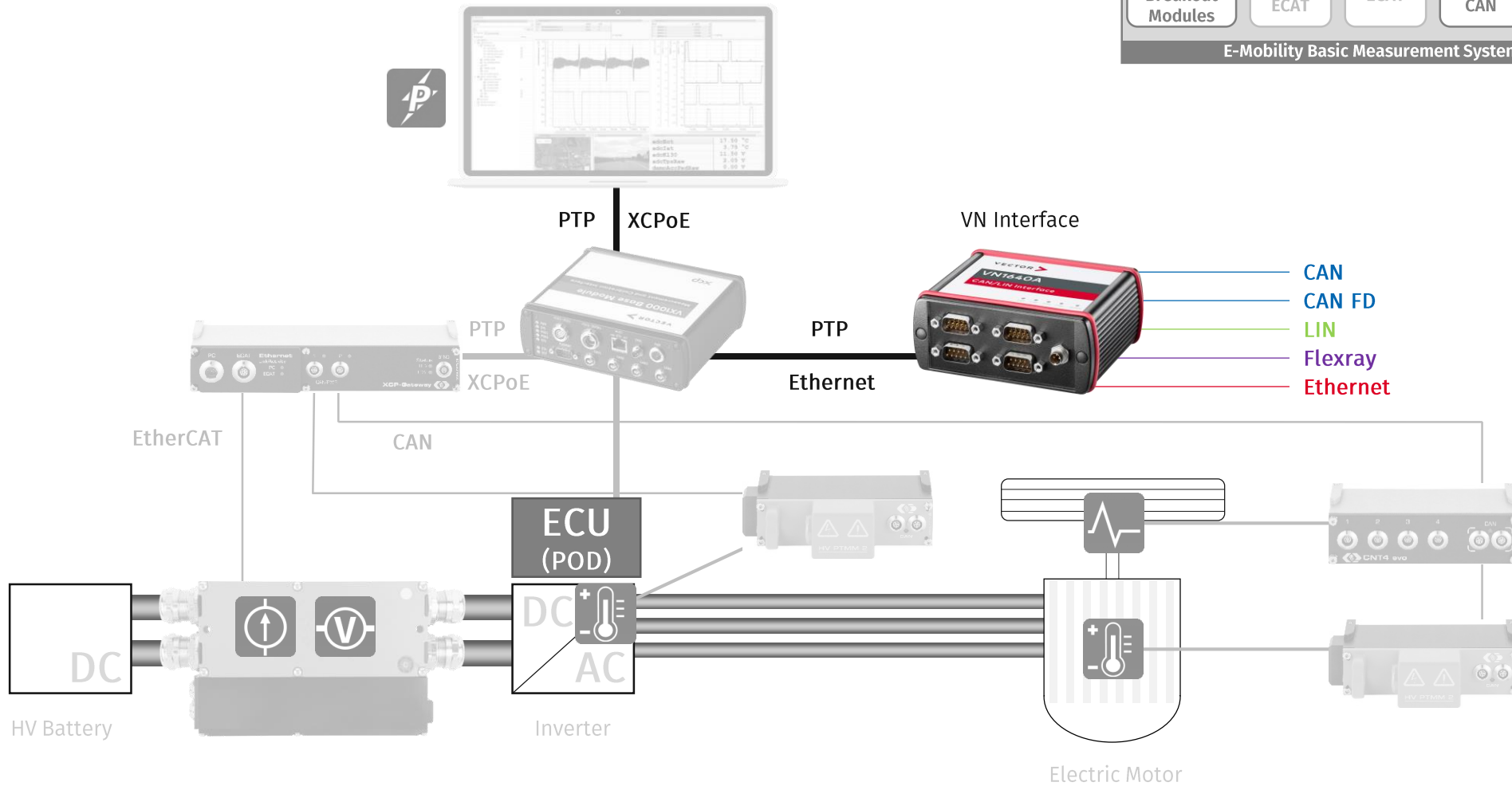
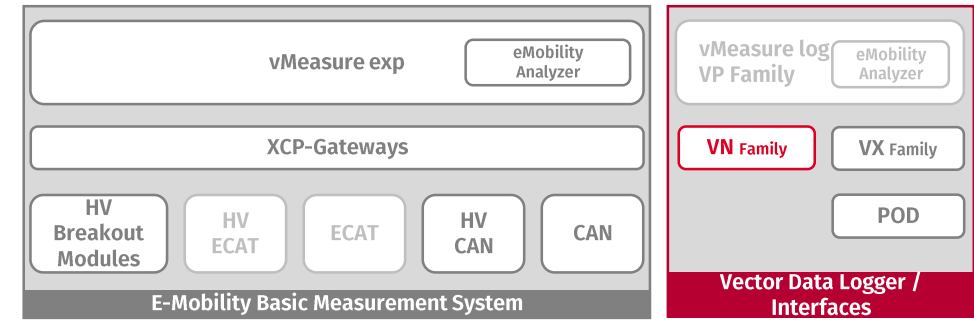

VN Family

- ▶ Interfaces for all automotive bus systems
- ▶ Time synchronous, low jitter and high bandwidth
 - CAN, CAN FD, FlexRay, Ethernet, LIN, Most



bus data
buses

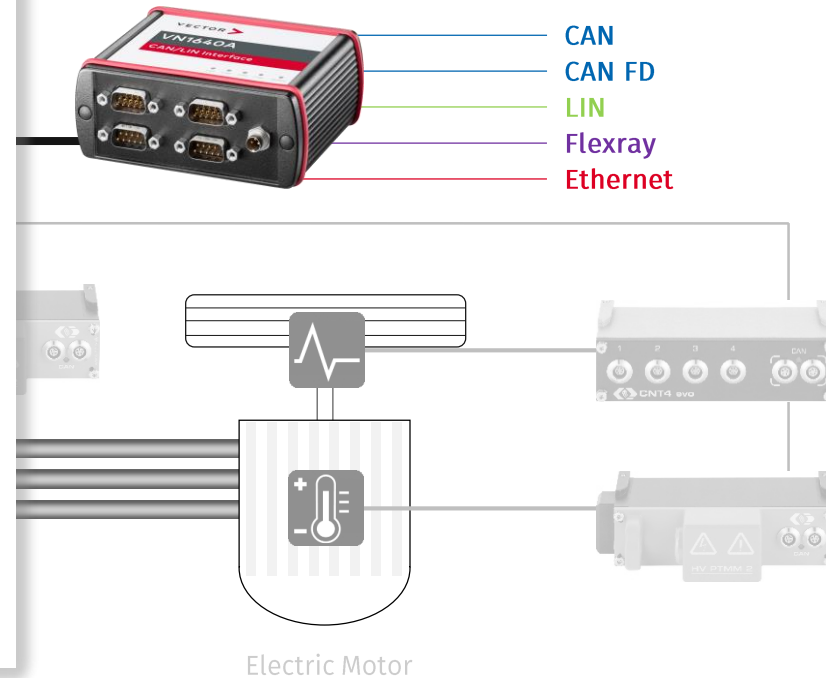
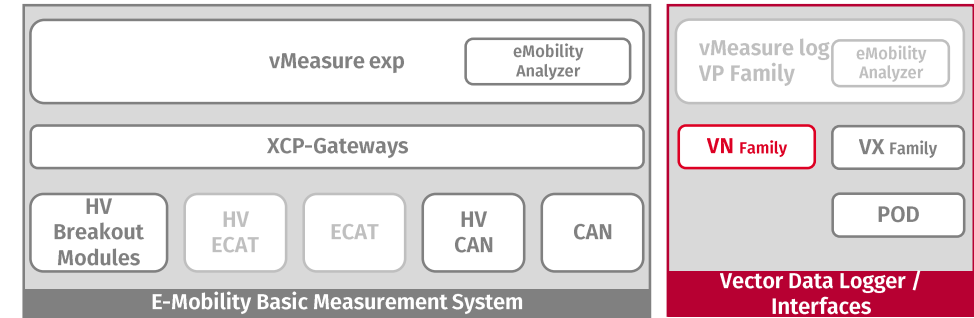

Basic measurement system + ECU data + bus data

Additional acquisition of measurement data from vehicle buses

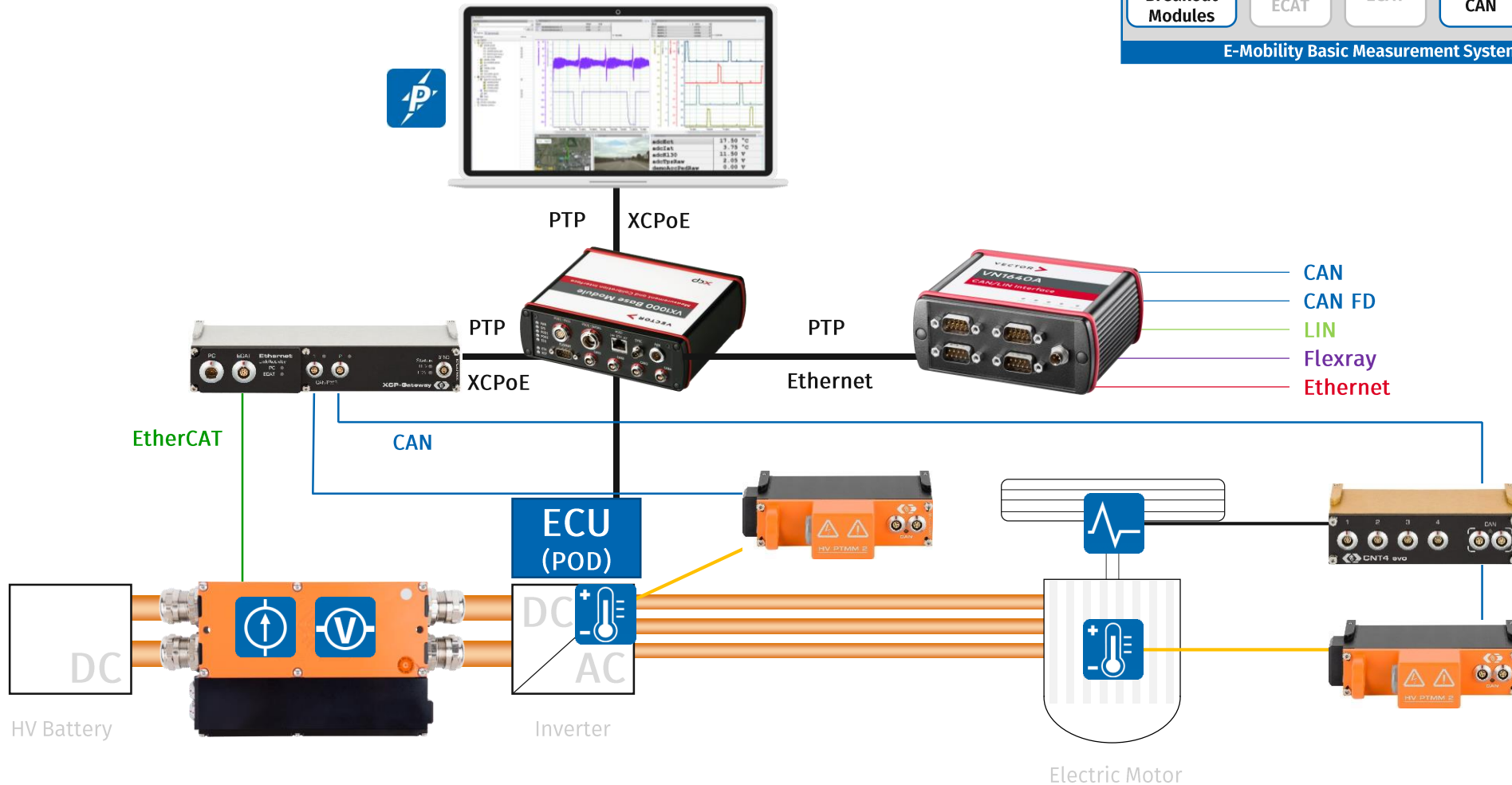
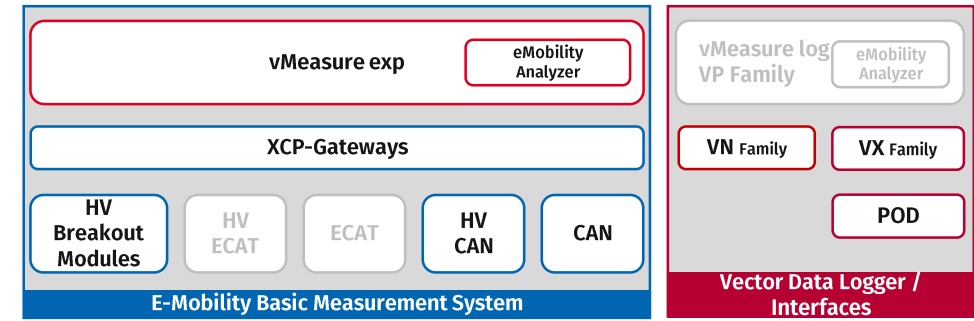

Challenges for measurement technology

- ✓ ▶ Distributed measurement points
 - decentralized and modular measurement system
- ✓ ▶ Synchronous acquisition of physical measurement variables
 - Power measurement requires 100% synchronous sampling of current and voltage
- ✓ ▶ Synchronous acquisition of ECU data and bus data
- ? ▶ **Autonomous acquisition, processing and storage of measurement data streams**

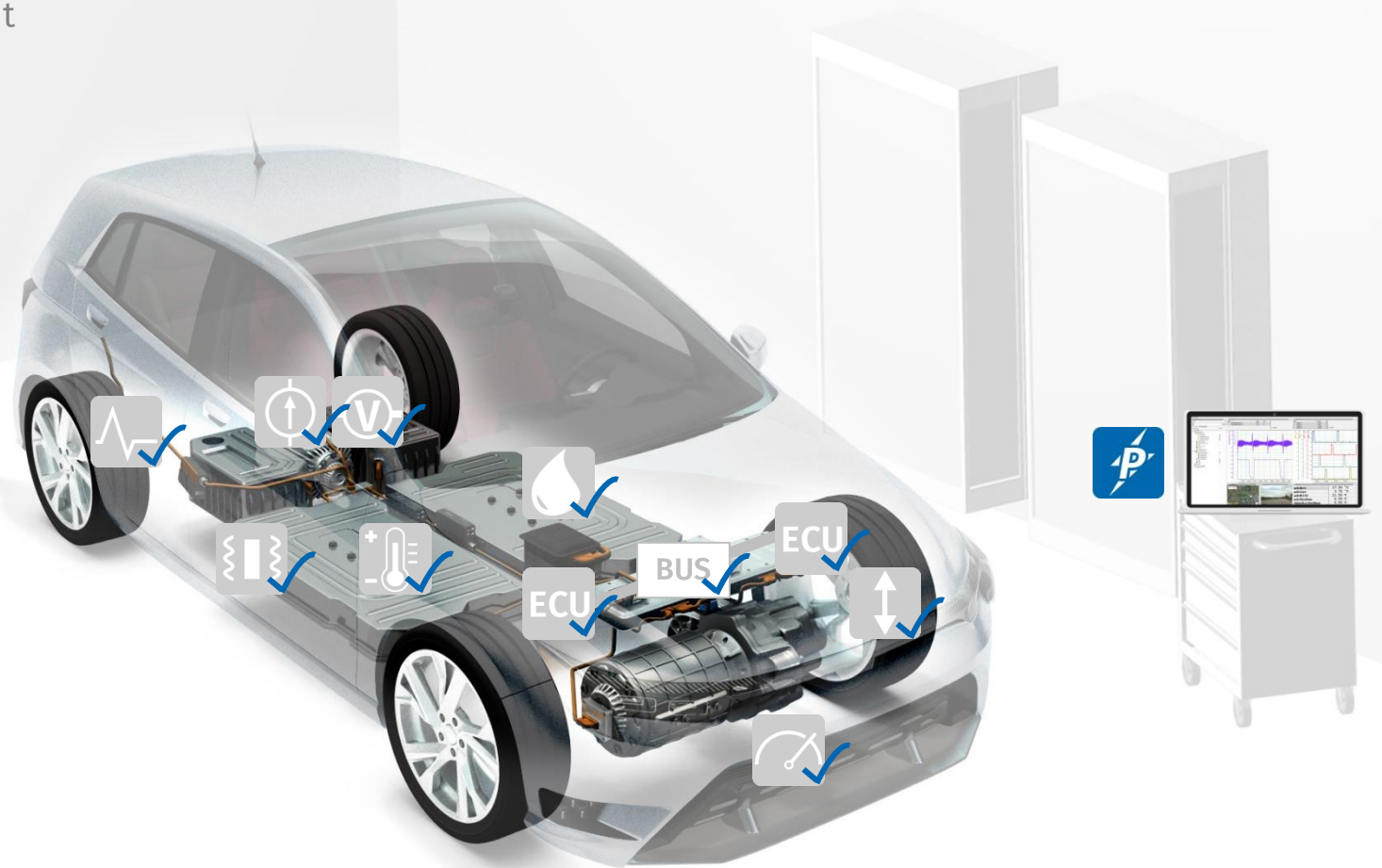

Autonomous measurement data acquisition

Processing and storage

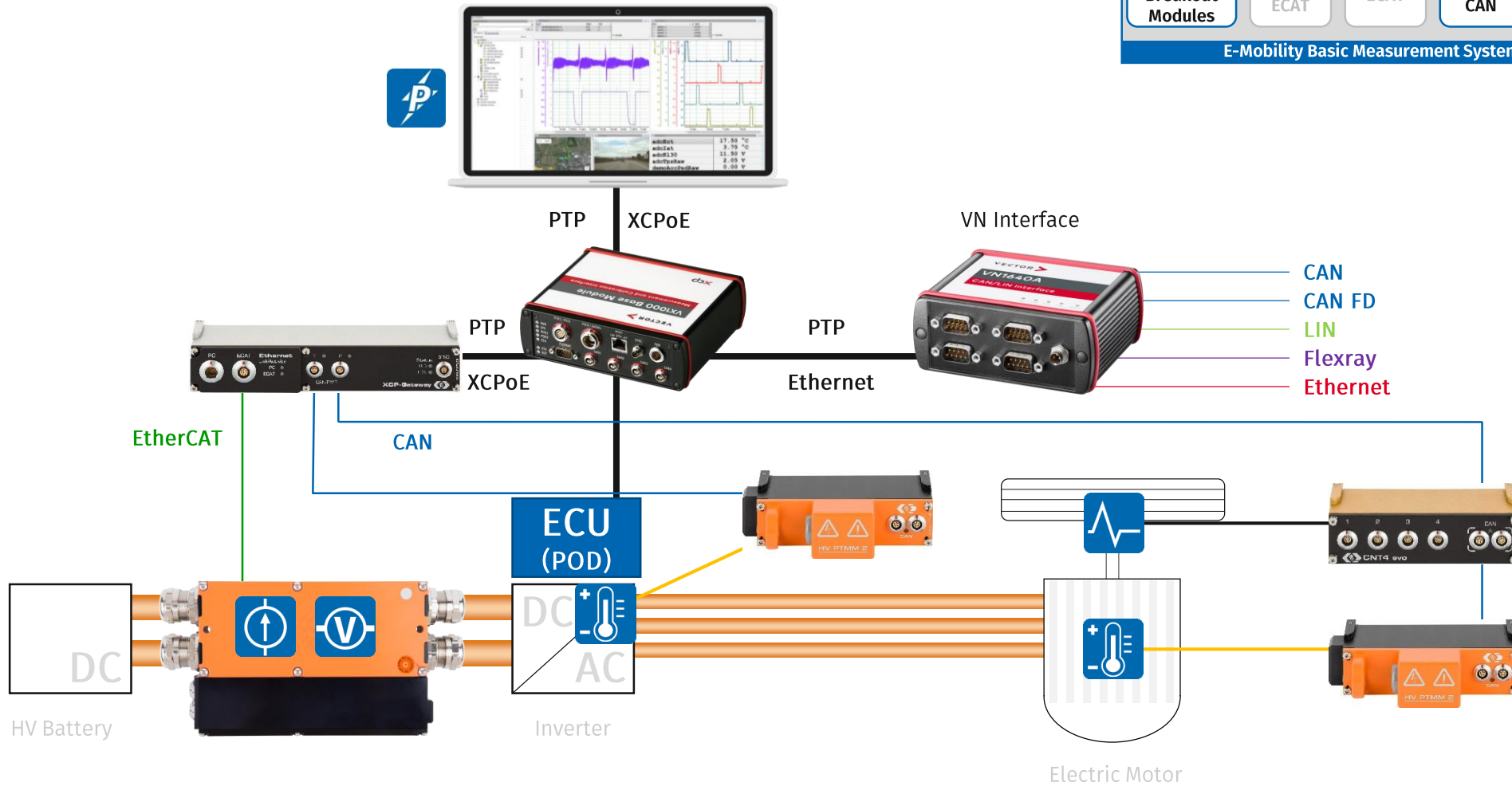
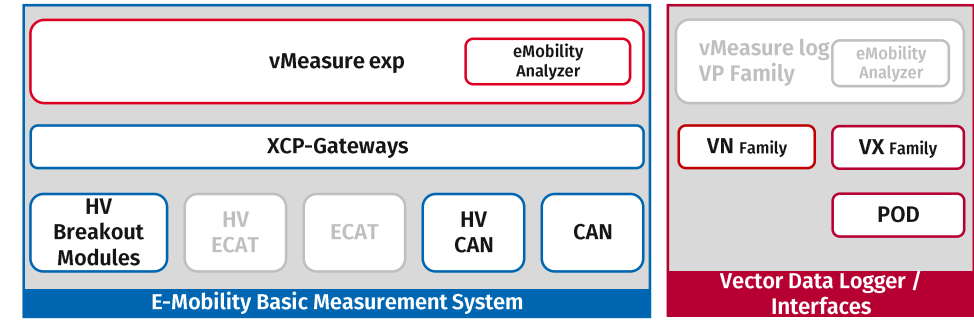

Autonomous measurement data acquisition

Processing and storage

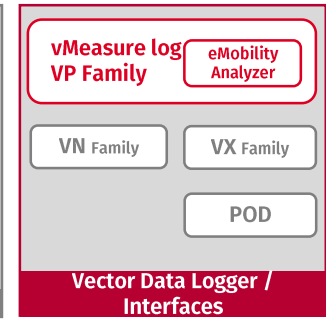
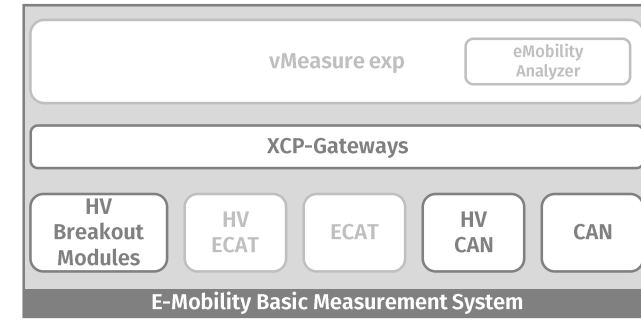
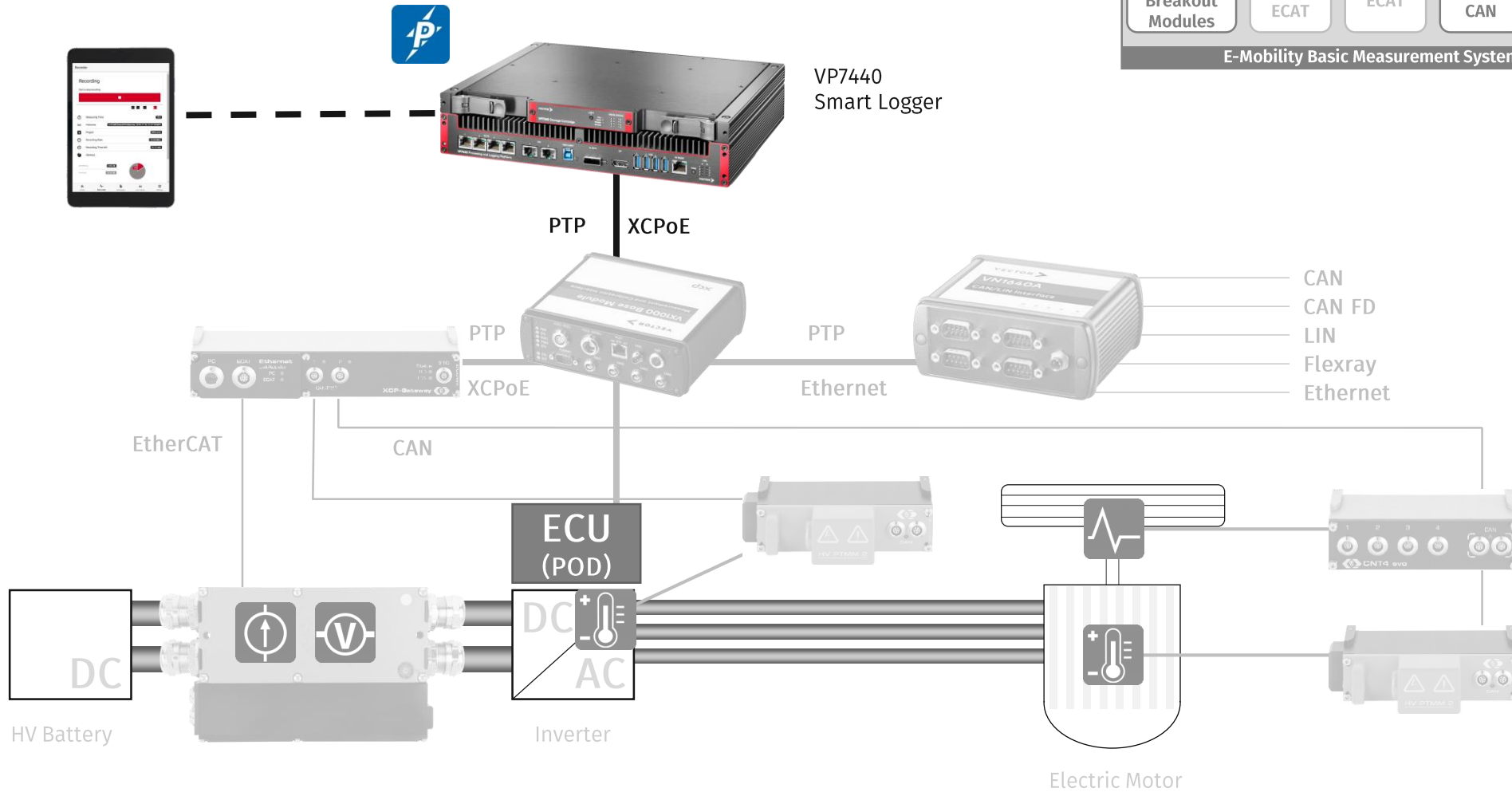

Autonomous measurement data acquisition

Processing and storage

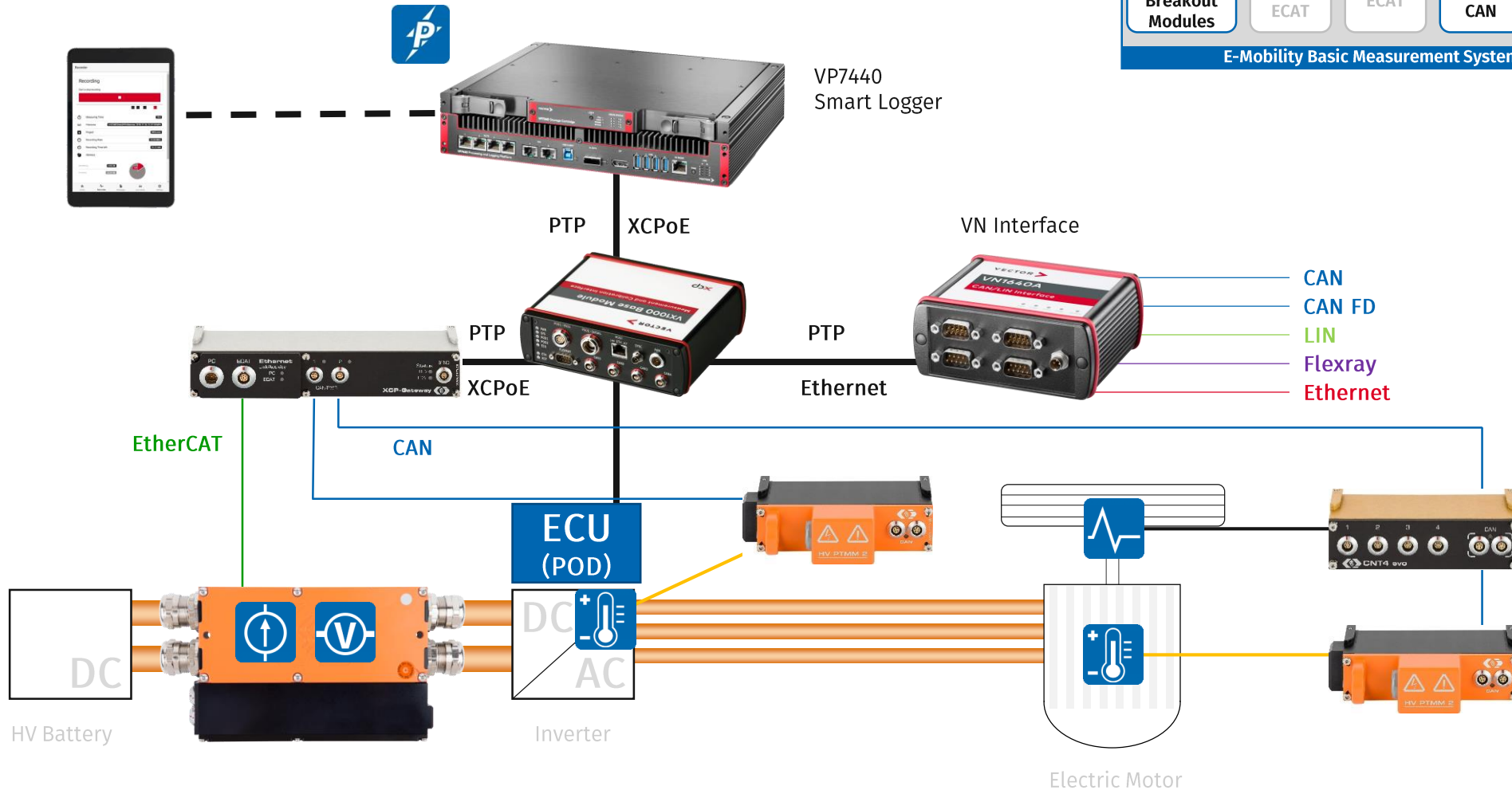

vMeasure exp		eMobility Analyzer	
XCP-Gateways			
HV Breakout Modules	HV ECAT	ECAT	HV CAN
CAN			
vMeasure log VP Family		eMobility Analyzer	
VN Family		VX Family	
POD			
Vector Data Logger / Interfaces			

The Vector CSM E-Mobility Measurement System

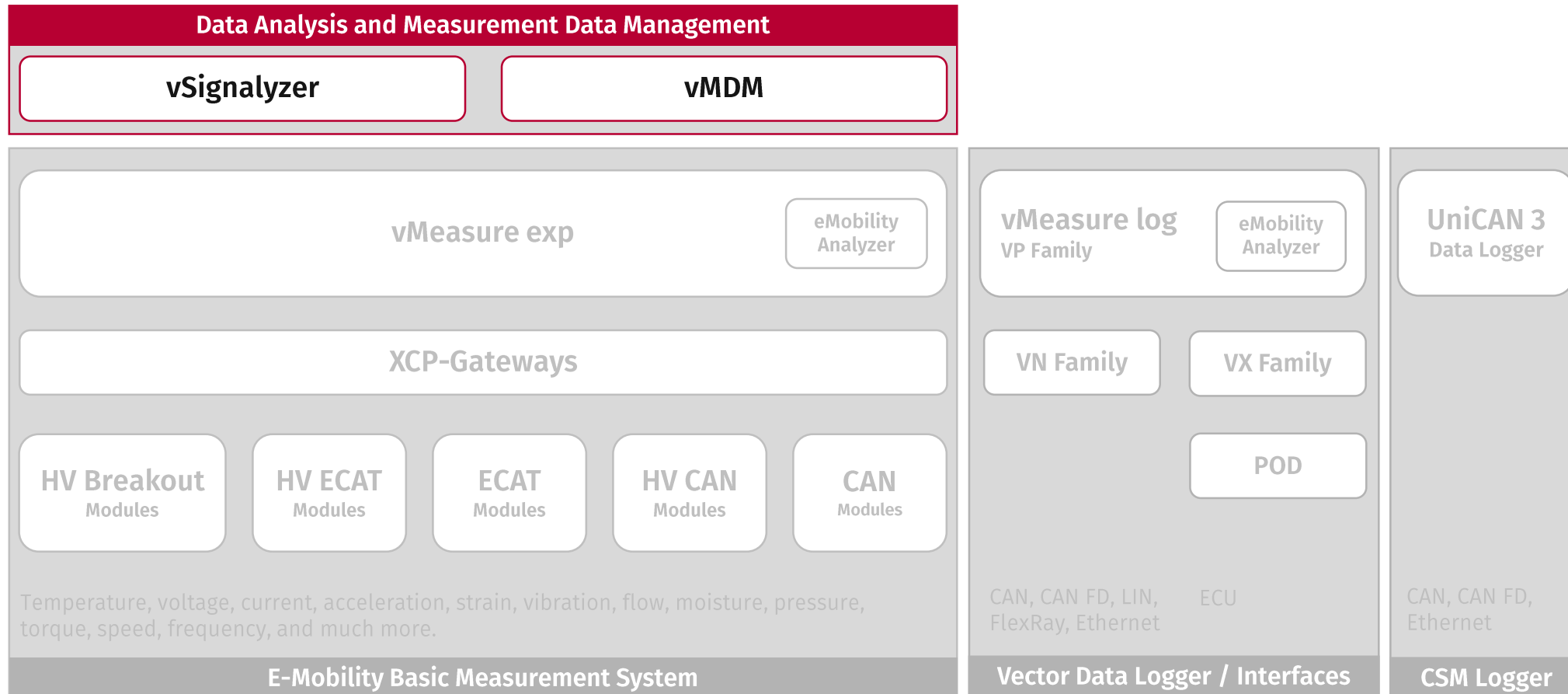

Data analysis and measurement data management

vSignalyzer

- ▶ Professional data analysis with data mining
- ▶ Optimized for the analysis of multiple, even very large measurement files
- ▶ Automated analysis and evaluation



vMDM

- ▶ Scalable measurement data management for very large numbers of measurement files from driver tests or test bench runs
- ▶ Secure storage on server and cloud
- ▶ Secure access, convenient searching and reporting

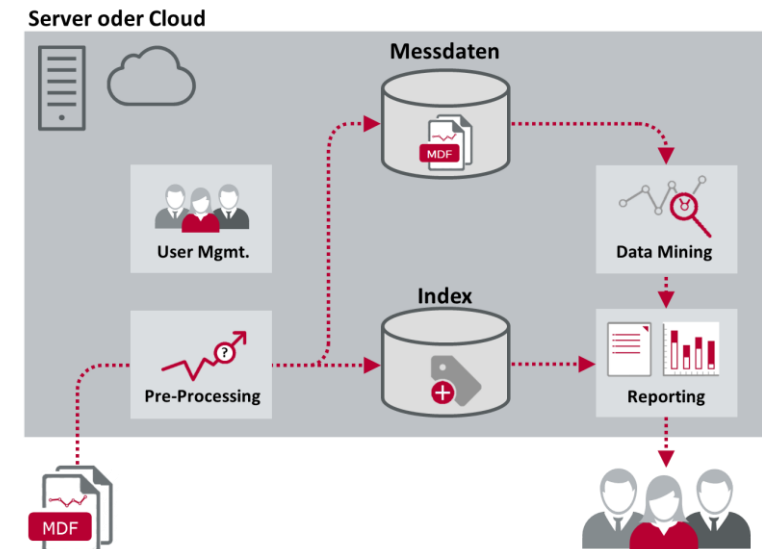

The Vector CSM E-Mobility Measurement System

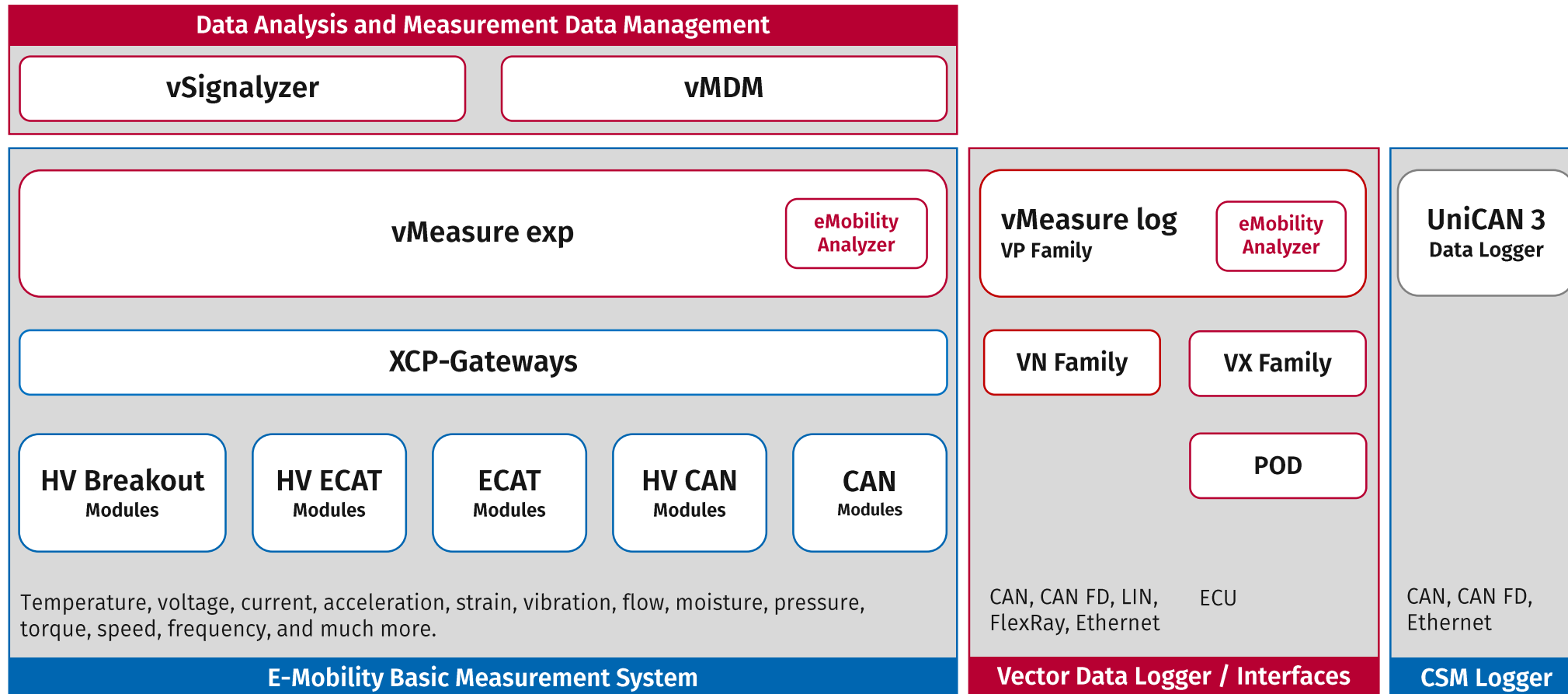

Features and benefits of the Measurement System

- ▶ **Decentralized, scalable measurement system** for vehicle and test bench with high-performance e-mobility online analysis
- ▶ Extremely compact, robust and fail-safe **measurement modules for HV and NV environments**
- ▶ **Synchronous acquisition of measurement data** from measurement modules, vehicle buses and ECUs
- ▶ **Direct measurement of current and voltage** in high-voltage lines at up to 1 MHz
- ▶ Multi-channel **real-time power analysis**
- ▶ **Raw data recording**, powerful signal analysis and evaluation incl. data mining

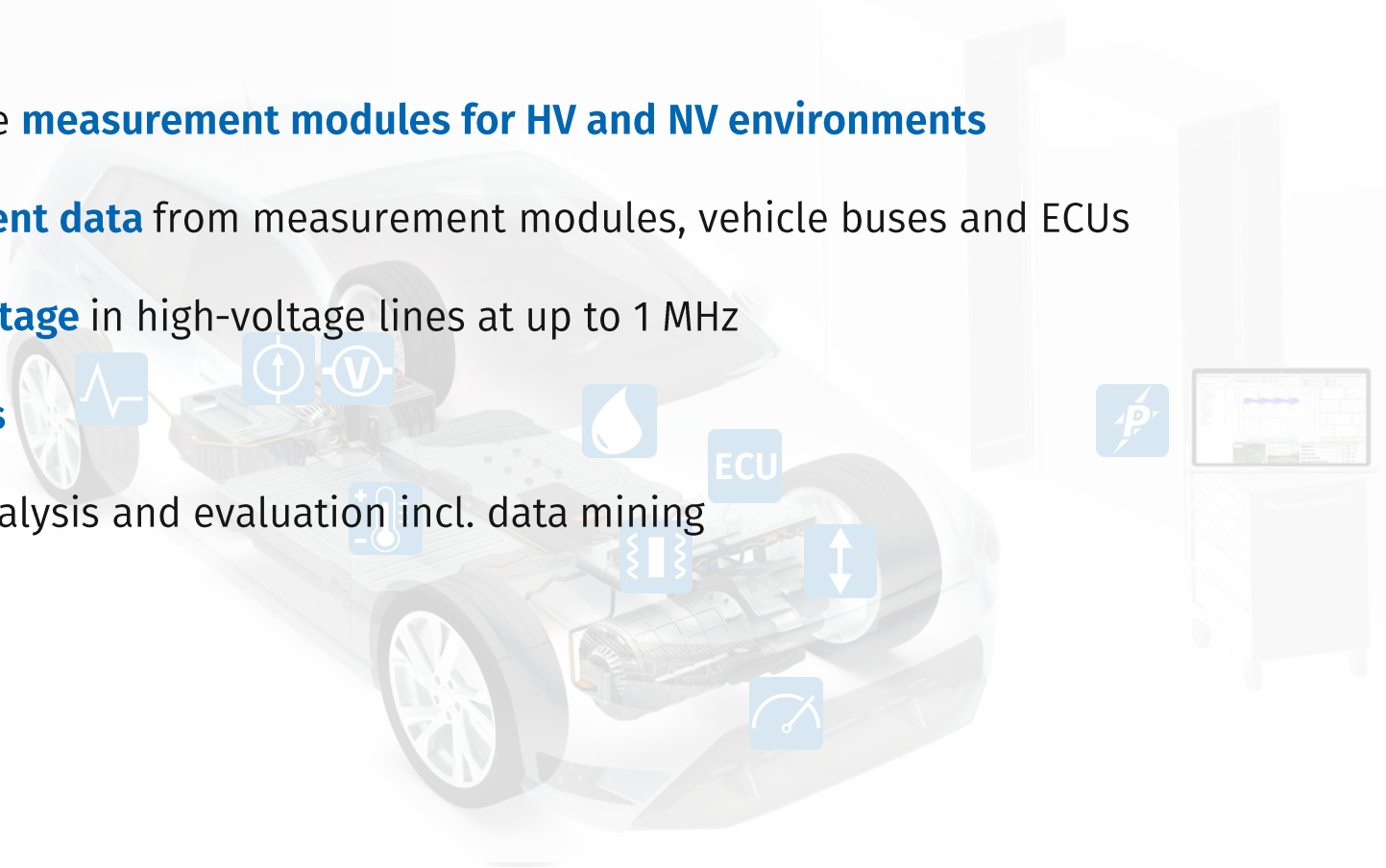

Features and benefits of the Measurement System

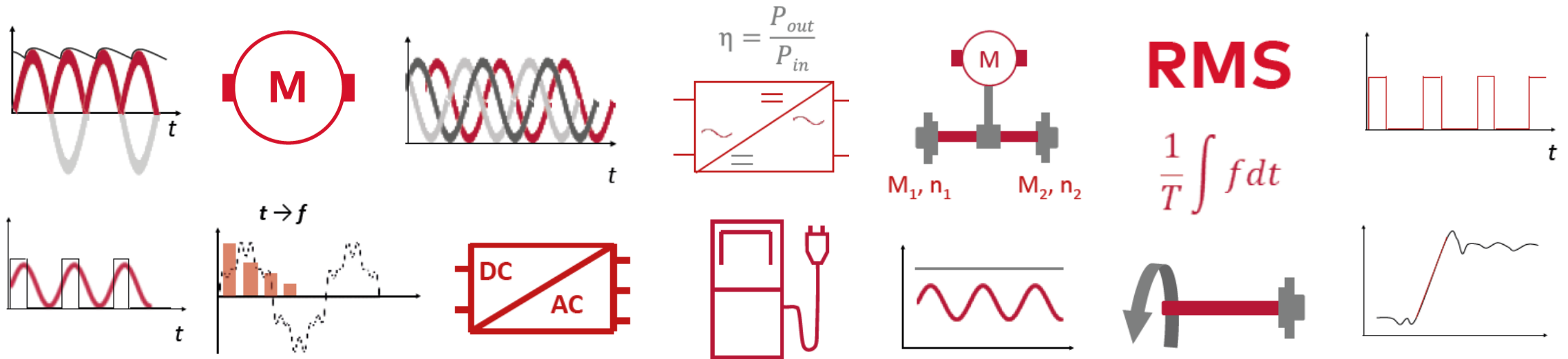

The E-Mobility measurement system is constantly being expanded with customer applications. You will receive new analysis tools free of charge with each Vector software release. New measurement modules from CSM open up applications for all areas of electromobility.

About CSM

CSM has been setting technological standards for decentralized measurement technology in vehicle development for over 35 years. Our CAN bus and EtherCAT® measurement devices support worldwide renowned vehicle manufacturers, suppliers and service providers in their developments.

Continuous innovation and long-term satisfied customers are our guarantee for success. Together with our partner Vector Informatik, we have developed an easily scalable and powerful E-Mobility Measurement System for hybrid and electric vehicles and are constantly expanding the areas of application. With our high-voltage safe measurement systems designed for fast and synchronous measurements and power analyses, we actively accompany the change to **E-Mobility**.

CSM GmbH (Germany, International)
Raiffeisenstraße 36
70794 Filderstadt
Phone: +49 711 - 77 96 40
email: sales@csm.de

CSM Products, Inc. USA (USA, Canada, Mexico)
1920 Opdyke Court, Suite 200
Auburn Hills, MI 48326
Phone: +1 248 836-49 95
email: sales@csmproductsinc.com

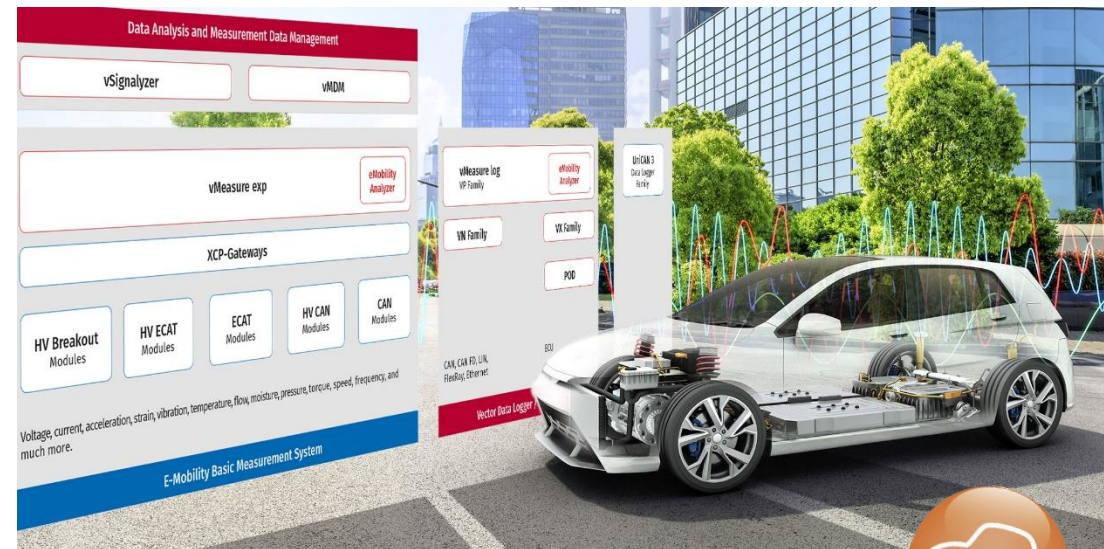

For more information and the current dates
of CSM Xplained, please visit

www.csm.de/webseminars



CSM Xplained
measurement technology